

DIGI★STAR

PRECISELY

ST3400 Operators Manual



DIGI★STAR

PRECISELY

Ft. Atkinson, Wisconsin USA

DIGI★STAR

PRECISELY

Pannigen, The Netherlands

www.digi-star.com

This Page Intentionally Blank.

Table of Contents

TECHNICAL SPECIFICATIONS.....	1
SAFETY DURING USE	2
Cleaning	2
Moving Seed Tender.....	2
Charging Battery and Welding.....	2
INDICATOR OVERVIEW	3
Standard Connector	4
EZ Mate Connector, Optional	5
Crown Connector, Optional	5
Basic Definitions.....	5
GENERAL OPERATION	6
Turn on Indicator	6
Zero Balance Indicator	6
Tare and Net/Gross.....	6
Automatic Scale Mode.....	8
Manual Mode	9
Print Key	9
DETAILED OPERATION	10
Using BIN Function	10
Using the M+, RM and CM Options	13
To Clear Memory	15
Printing Weight from Memory	15
AUTOMATIC MODE SEED DISPENSING METHODS	16
Seed Dispensing Options	16
ADVANCED COMMANDS	18
Preset	18
Clear Preset.....	18
Preload A Tare Value	18
SYSTEM SETUP	19
Number of Bins, BINNUM 132	19
Tolerance, TOLER 442.....	19
Calculating Auger Tolerance	19
COMMONLY USED DIRECT ACCESS NUMBERS (D.A.N.)	20
Pre-Alarm (P-ALM).....	20
Number of Bins (BINNUM)	20
Tolerance (TOLER).....	21
Save Battery (AUTOFF)	21
OTHER FUNCTIONS.....	22
Hold	22
Using Dimmer Option	22
Field.....	22
Function and Select Keys	23
MENUS AND ACCESS NUMBERS	24
Access To Menus.....	24
MENUS AND CALIBRATION	25
Change Setup And Calibration Numbers	29
INSTALLATION	30
Indicator Mounting.....	30
Cable Connection.....	32

Auger Control Wiring	32
Bottom Panel Cable Connections	33
Connect Load Cells to J-Box (Standard Indicator).....	34
Load Cell Direction.....	34
OPTIONAL EQUIPMENT	35
Transmitter/Receiver	35
Data Transfer Options	35
Printer.....	35
TROUBLESHOOTING	36
QUICK REFERENCE.....	38
MANUAL – Manual Mode	38
AUTO – Automatic Scale Mode	38
Auger Tolerance	38
Setting and Clearing BIN Weights.....	38
QUICK REFERENCE.....	42
MANUAL – Manual Mode	42
AUTO – Automatic Scale Mode	42
Auger Tolerance	42
Setting and Clearing BIN Weights.....	42

All rights reserved. Reproduction of any part of this manual in any form whatsoever without Digi-Star's express written permission is forbidden. The contents of this manual are subject to change without notice. All efforts have been made to assure the accuracy of the contents of this manual. However, should any errors be detected, Digi-Star would greatly appreciate being informed of them. The above notwithstanding, Digi-Star can assume no responsibility for errors in this manual or their consequence.

© Copyright! 2012 Digi-Star, Fort Atkinson (U.S.A.).

TECHNICAL SPECIFICATIONS

SIZE

10.25" long x 8.0" high x 4" wide (260mm x 190mm) **DISPLAY RESOLUTION**
.01, .02, .05, .1, .2, .5, 1, 2, 5, 10, 20, 50, 100

WEIGHT

4.5 lbs (2.04 Kg)

DISPLAY UPDATE RATE

Selectable: 1, 2, 3, 4 times/sec.

HELP MESSAGES

Context sensitive help messages in 10 languages
Long messages are scrolled

MAX. DISPLAY RESOLUTION

Adjustable to 40,000 counts max.

TRANSDUCER EXCITATION

8 volts D.C. Nominal
Capable of driving ten 350 Ohms transducers
Short circuit proof

ZERO TRACKING

Selectable, On/Off

ATC

Auto Temperature Compensation of the internal circuitry for high accuracy weighing measurements

SPAN ACCURACY

$\pm(.1\% + .005\% / ^\circ\text{F})$ or $(.1\% + 0.009\% / ^\circ\text{C})$ full scale ± 1 output count

TRANSDUCER SIGNAL

Compatible with transducers having full scale indicator transfer characteristics greater than 0.25 mv/v

MOTION DETECTION

Selectable, On/Off

"AUTO RANGE"

(Selectable) To increase display counts at weight values of 300 and 600 display counts.

ZERO ACCURACY

$(.005\% / ^\circ\text{F})$ or $(0.009\% / ^\circ\text{C})$ full scale ± 1 output count for 0.5 mv/v transducer

CONNECTOR

AMP plastic weather resistant circular connector. Gold contacts.

ENVIRONMENTAL ENCLOSURE

IP65, IEC 529

POWER REQUIREMENTS

10.5 to 16.0 V.D.C.
160 mA nominal with four 350 Ω L.C.

WEIGH ALGORITHM

4 internally selectable digital filters to optimize performance
(General, Slow, Fast and Lock-on)

SET UP AND CALIBRATION

Via front panel

HOLD MODE

Used in mobile applications to stabilize displayed weight while moving the scale

GROSS RANGE

999,999 max. display

NON-VOLATILE MEMORY

EEPROM for balance

LOW BATTERY WARNING

Enabled at 10.5V nominal

OPERATING TEMP

-29 $^{\circ}\text{C}$ to 60 $^{\circ}\text{C}$ -20 $^{\circ}\text{F}$ to 140 $^{\circ}\text{F}$

POUND/KILOGRAM

Selectable

REMOTE INPUTS

Sense Auger / Conveyor Start

DISPLAY

STD EZ 6 Digit LCD 1.0" high
EZ VIEW6 Digit LCD 1.7" high

RELAY OUTPUT

10A, Internal Fuse

SAFETY DURING USE



Caution

Cleaning

Do not use running water (high pressure cleaners, hoses) to clean the indicator.



Caution

Moving Seed Tender

An accidental button press may activate the auger. The scale should be turned off or in "HOLD" mode and the manufacturer's controls turned off or disengaged when moving, transporting or maintaining the seed tender.

Charging Battery and Welding



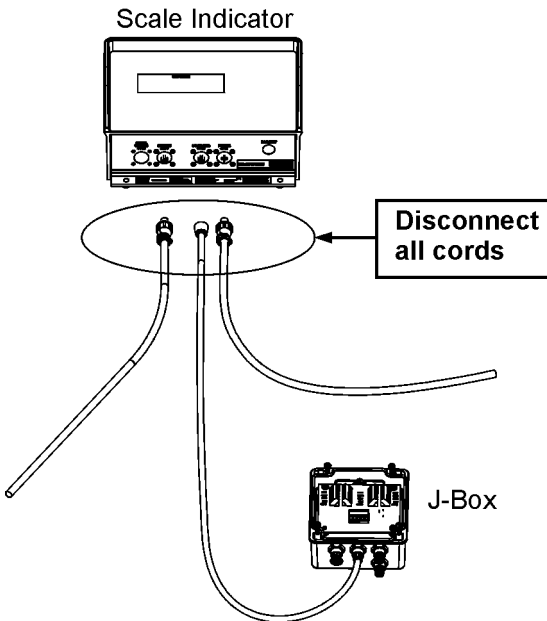



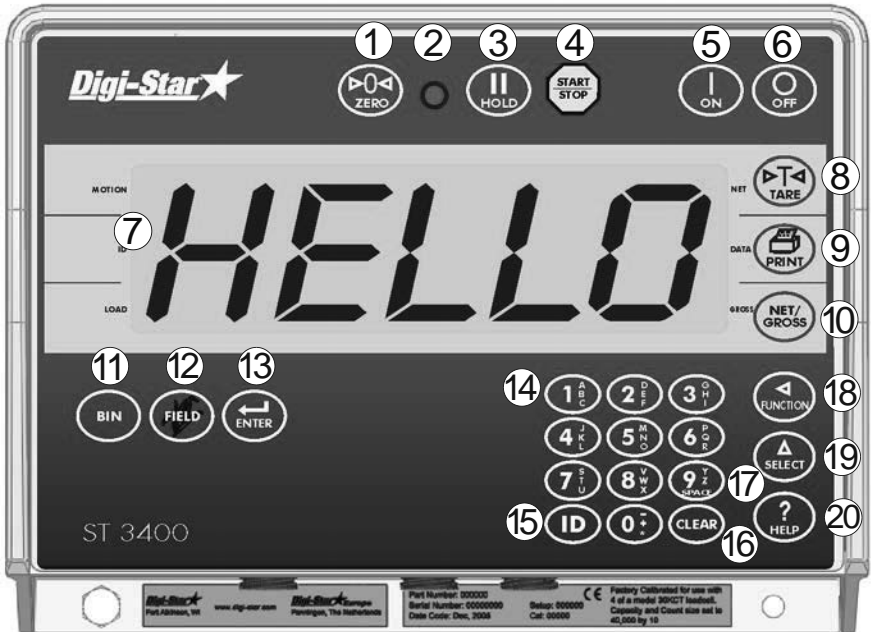

Disconnect all cables from the weighing indicator before charging the battery or welding on the machine. If cables are left connected, the weighing indicator and connected load cells could be damaged.



INDICATOR OVERVIEW



Note: See page 30-34 for installation instructions.

- ①  – press and hold for 3 seconds to zero balance.
- ② Pre-Alarm Light – starts flashing and alarm sounds when weight is within preset limit. See page 20.
- ③  – holds displayed weight when moving machine.
- ④  – see page 16.
- ⑤  – turns indicator on. Pressing while on will run self test.
- ⑥  – turns indicator off.
- ⑦ Display Window – displays current actions.
- ⑧  – temporary zero (Net mode).
- ⑨  – records to memory or prints displayed weight.
- ⑩  – toggles between Net and Gross weights.

- 11 **BIN** – selects bins in memory, program bins.
- 12 **FIELD** – enter field name to print.
- 13 **ENTER** – accepts change or proceeds to next item.
- 14 **Keypad** – input numbers or letters as required.
- 15 **ID** – used to enter label numbers for weight value to be displayed and printed.
- 16 **CLEAR** – clear current command.
- 17 **9 SPACE** – add space in command.
- 18 **FUNCTION** – performs tasks displayed by select.
- 19 **SELECT** – displays additional tasks.
- 20 **HELP** – view for additional information.

Standard Connector

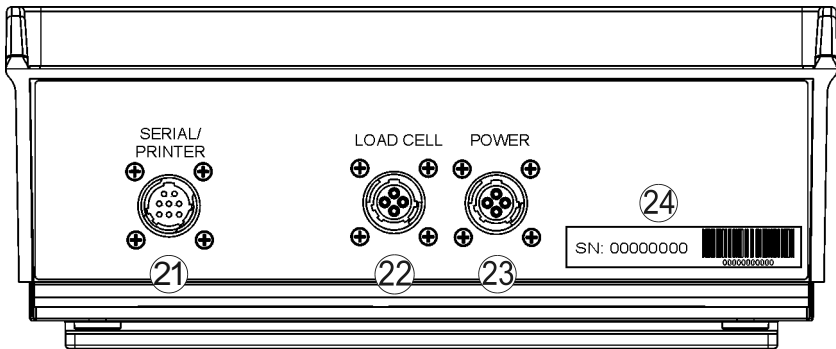

- 21 **Serial/Printer Port** – communicate with computer and other digital input/output devices.
- 22 **Load Cell Port** – for J-Box cord (Standard Connector) or individual load cells (EZ Mate and Crown Connectors).
- 23 **Power Port** – for control box with cord.
- 24 **Serial Number Plate** – Serial Number of indicator.

EZ Mate Connector, Optional

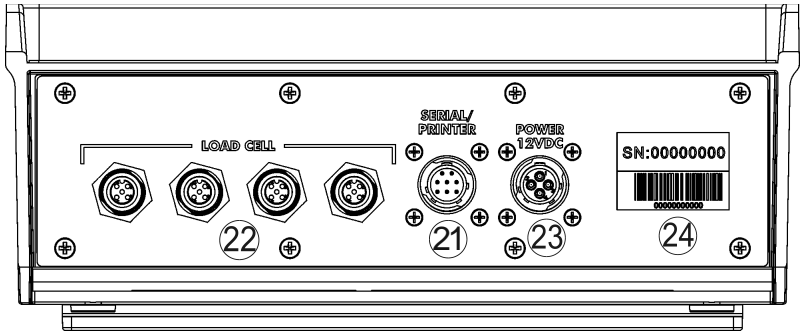

Crown Connector, Optional

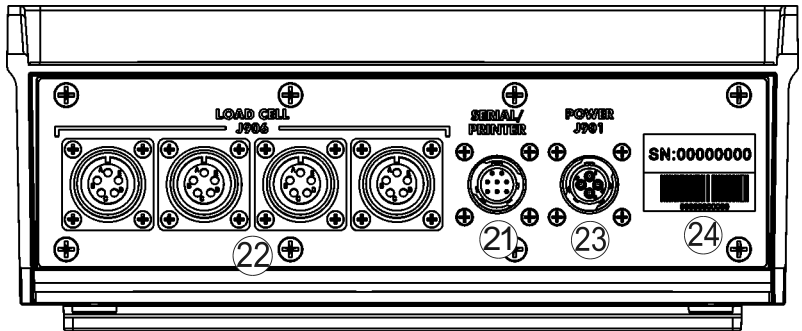

Basic Definitions

Preset: Enter seed amount to send to planter.

Direct Access Numbers (D.A.N.): Three-digit number used to access Menus.

Menu: View menus 1,2,3,4 and calibrate. See page 24.

Setup: Change setup and calibration numbers. See page 29.

M+: Adding weight to weight memory.

RM: Recall weight memory.

CM: Clear weight memory.

MS: Memory Store, overwrites memory.

Dimmer: High/Low backlight control. Toggle between high/low using



Help: Explains operation of select and function key.

Total: Displays total of BIN weights when *BINNUM* is active.

GENERAL OPERATION

Turn on Indicator



1. Press .

Zero Balance Indicator

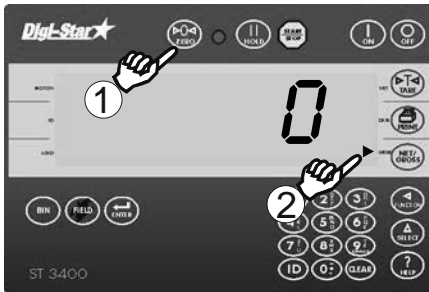

1. Press and hold  for 3 seconds to zero balance indicator.
2. Indicator ready to weigh when flashing arrow points to GROSS.

Tare and Net/Gross

Tare is a temporary zero (Net Weight) to display total weight (Gross Weight) Press .



1. Starting weight displayed.
Example: 4000



2. Press  to set weight to zero. Flashing arrow points to NET.



3. Add more weight. Example: 300



4. Press  to show GROSS weight of starting weight of 4000 pounds plus added 300 pounds. Flashing arrow points GROSS.



5. Press . 300 pounds displayed flashing arrow points NET.

Automatic Scale Mode

ST3400 Indicator Controls Shutoff

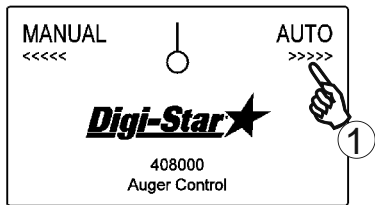

1. Verify control box switch is set to AUTO.

NOTE: Control box type may vary, standard control shown.



2. Press **BIN** until active seed tender bulk bin is selected.

NOTE: Bin function is disabled when *BINNUM* is set to OFF. See page 20 to enable BIN function.



3. Determine seed weight to fill each planter hopper.

4. Use keypad to enter PRESET weight.

5. Press **ENTER** to store. Display will show *PRESET STORED*.

6. Move seed tender chute to planter hopper.



7. Dispense seed to planter using method(s) from page 16.

8. Auger will turn off when reaching PRESET weight.

9. Repeat steps 6-8 until planter is filled.

Manual Mode

Operator controls seed dispensing;
Indicator monitors weight

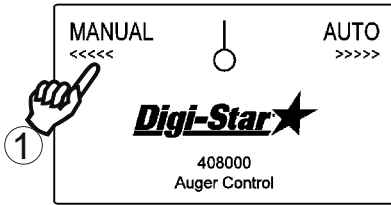

1. Verify control box switch is set to MANUAL.
2. Follow manufacturer's instructions to operate seed tender.
3. Operator controls seed dispensing and shutoff.

NOTE: Control box type may vary, standard control shown.

Print Key



1. Press  to send data to printer or PC.

NOTE: Print format PRTST3 shown.

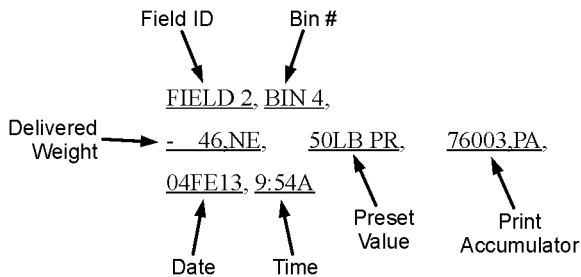

DETAILED OPERATION

Using BIN Function

NOTE: BIN function is disabled when *BINNUM* is set to OFF. See page 20 to enable BIN function.

Selecting Seed Tender Bin



1. Press **BIN** once to display active seed tender bin. The display will show *BIN X* for the active bin.



2. Press **BIN** until desired bin is displayed. The display will alternate from *BIN X* to bin weight.



3. When a BIN is selected, only the selected BIN and TOTAL weight values change. The other BIN values do not change until selected.

Viewing TOTAL weight



1. Repeatedly press **SELECT** until *TOTAL* is displayed.
2. Press **FUNCTION**; total of BIN weights display for two seconds.

Setting Seed Tender BIN Weights

Assign known seed weight to BIN memory.



1. Press **BIN** until desired seed tender bin is displayed.
2. Enter BIN weight with keypad.

NOTE: BIN weight can be stored when *BINNUM* set to OFF. No confirmation message is displayed.



3. Press **BIN** to store. *BIN X* and *STORED* will be displayed.

Example: 1300 pounds is loaded into BIN 2. Press **BIN** until BIN 2 displays. Type in the weight, 1-3-0-0. Press **BIN** to store.

Clearing BIN Weights

Clears BIN memory before loading seed tender.



1. Press **BIN** until desired bin is displayed.



2. Press and hold **ZERO** to clear BIN weight.
3. Load seed into seed tender bin. Displayed weight is BIN seed weight.

Using the M+, RM and CM Options



1. Add weight on scale. Example: 500 pounds



2. Repeatedly press  until *M+* is displayed.



3. Press ; *500* pounds and *RM* briefly displayed. 500 pounds added to indicator memory and indicator in gross weight mode.



4. Put another weight on scale.
Example: 1000 pounds



5. Repeatedly press  until *M+* is displayed.



6. Press . Indicator adds 1000 pounds to 500 pounds in memory and *RM* flashes.



7. Repeatedly press  until *RM* is displayed.



8. Press .

9. Total of both weights, 1500 pounds, displays, indicator switches to gross weight mode.

(See page 15 to print weight in memory.)

To Clear Memory





1. Repeatedly press  until *CM* displayed.
2. Press .

Printing Weight from Memory



1. Repeatedly press  until *RM* displayed.



2. Press  to show weight in memory. Example: 1500 pounds
3. Press  while weight displayed.

AUTOMATIC MODE SEED DISPENSING METHODS

Seed Dispensing Options

The following methods may be used to dispense seed while in AUTO mode. Please note that not all methods may be available on your seed tender model. In all methods, display will alternate between "PRESET" and remaining weight. Auger will turn off automatically when reaching PRESET weight.

Option 1



1. Press  on indicator.

NOTE: Not applicable to variable throttle shutoff models. Use Option 2 or 3 to start seed dispensing.

Option 2

Refer to Seed Tender Manual for details.



Press auger button or throttle switch on seed tender.

NOTE: The wired button on standard seed tenders may need to be held down while dispensing seed or PRESET function may restart during operation.

Option 3

Refer to Seed Tender Manual for details.



Press auger speed increase or throttle up button on radio control for seed tender.

NOTE: This may be a toggle switch, momentary button, 2 buttons for auger ON/OFF, or Fast/Slow controls.

NOTE: The manufacturer's button may need to be pressed 2 times to fill the next planter hopper on standard seed tenders

1. Press to disengage or reset OEM controls.
2. Press to dispense seed again. Some radio models may require the 'Auger OFF' to be pressed first before pressing 'Auger ON' to reset the system at each hopper fill.

Option 4



1. Press optional Digi-Star Transmitter button.

NOTE: Not applicable to variable throttle shutoff models. Use Option 2 or 3 to start seed dispensing.

Tips and practices for best accuracy

In order to achieve the greatest accuracy in seed dispensing weight, fill the planter hopper(s) in the most consistent manner as possible.

- Dispense seed on level ground.
- Avoid areas of high wind.
- Fill all planter hoppers in the same manner. The auger and seed chute will hold more seed when fully extended than when vertical, and may change the weight of the seed dispensed.
- When filling with a fully extended seed chute, the auger tolerance (DAN 442) may need increasing compared to filling the same planter with a short chute.
- The seed chute should rest on or against the planter hopper the same way for every fill.
- Do not let the seed chute hang free or rest on the seed as it is filling.
- For fast moving augers or conveyors, a restrictor plate may be required from your seed tender manufacturer to better control the seed dispensing rate.
- When using seed boxes, adjust the slide door to slow down the seed dispensing rate if needed.
- Adjust the tolerance for the seed type and weight being used.

ADVANCED COMMANDS

Preset

The Preset feature is used to fill planter hoppers to the programmed weight.



1. Enter desired preset weight.
2. Press **ENTER**. Indicator rounds weight to nearest display count; displays *PRESET STORED*.

Clear Preset



1. Press **CLEAR** to clear preset value.

Preload A Tare Value

Weighing containers after already loaded. If weight of container is known, a tare weight is preloaded in indicator and only net weight displayed.



Pre-Tare: enter 405, press **SELECT**, press **SELECT** to turn on.

1. Press and hold **ZERO** for 3 seconds to zero balance the indicator.
2. Add weight to container.
3. Enter known weight of unloaded container.
4. Press **TARE**. Press **NET/GROSS**.

SYSTEM SETUP

Auger Tolerance will be setup and changed as needed based on seed type or weight.

Number of Bins, BINNUM 132

Enter number of Seed Tender bulk bins. Refer to page 20 for details, D.A.N. 132.

Tolerance, TOLER 442

Enter Seed Tender auger tolerance weight. Refer to page 21 for details, D.A.N. 442.

Calculating Auger Tolerance

Auger tolerance is the weight offset of seed remaining in the seed tender auger or conveyor while filling the planter. This value is set to adjust for the delay of the auger to stop movement of seed sliding out of the seed chute. This value may need to change based on seed chute size, extended seed chute length, seed type, and seed weight. Set the "TOLER" value for the expected use of the seed tender.

1. Load at least 200 pounds of seed into the tender.
2. Park seed tender on level ground.
3. Collect three empty containers of same size and weight to hold 60 pounds of seed each.
4. Have other scale nearby that can measure one full container.
5. Either weigh empty container and zero scale or record container weight.
6. Enter PRESET of 30 pounds on indicator. 3-0-ENTER
7. Extend seed chute to normal distance and height of planter to fill.
8. Dispense seed in AUTO mode into one empty container. Refer to page 8, Automatic Scale Mode.
9. Weigh filled container.
10. Subtract PRESET weight from total weight:
 - a. Subtract container empty weight if needed

<u>Method:</u>		<u>Example:</u>
Total filled container	52	pounds (container with seed)
- 30lb PRESET	-30	pounds (PRESET number)
- Container	- 5	pounds (container, step 10.a)
= TOLER Weight	= 17	pounds (TOLER 442)





11. Enter weight value as "TOLER", D.A.N. 442. Refer to page 21.
12. Repeat steps 7-10 two more times to verify accuracy.
13. For tender dispensing too much seed, increase tolerance weight by the amount of overflow. For tender dispensing too little seed, decrease tolerance weight.

COMMONLY USED DIRECT ACCESS NUMBERS (D.A.N.)

Pre-Alarm (P-ALM)

Select weight or percentage method, enter value to activate early warning indicator reaching preset.





1. Enter 401 press .
2. Press  again to choose between WEIGHT and PERCENT.
3. Press .
4. Enter Pre-Alarm value. Press .

Number of Bins (BINNUM)

Program number of seed tender bulk bins. Set to OFF when not tracking individual bin weights.





1. Enter 132 press .
2. Press  again until number of seed tender bins is displayed.
3. Press  to save.

Tolerance (TOLER)

Sets weight offset for seed remaining in auger.





1. Enter 442 and press .
2. Set T Method to "Weight".
3. Press  to save.
4. Set TOLER to desired weight with keypad.
5. Press  stores setting.

Save Battery (AUTOFF)

Indicator turns off at set time.





1. Enter 111 and press . *AUTOFF* briefly displays.
2. Repeatedly press . Set time.
3. Press  to save.

OTHER FUNCTIONS

Hold



Hold mode prevents displayed weight from changing while moving.



1. Press  to enter Hold Mode.
2. Press  to return to Normal Mode.
3. If weight added in hold mode, press  to cancel hold.

Using Dimmer Option



1. Repeatedly press  until *DIMMER* is displayed.
2. Press  to dim backlight.

Field



1. Press  and enter the field name.
2. Press  to save.

Function and Select Keys



1. Repeatedly press  to get following options:

Preset: Enter seed amount to send to planter

Menu: View menus 1,2,3,4 and calibrate. See page 25.

Setup: Change setup and calibration numbers. See page 29.

M+: Adding weight to weight memory.

RM: Recall weight memory.

CM: Clear weight memory.

MS: Memory Store, overwrites memory.

Dimmer: High/Low backlight control. Toggle between high/low using .

Help: Explains operation of select and function keys.

Total: Displays total of BIN weights when BINNUM is active.

2. Desired option displayed, press  to activate.

MENUS AND ACCESS NUMBERS

Access To Menus



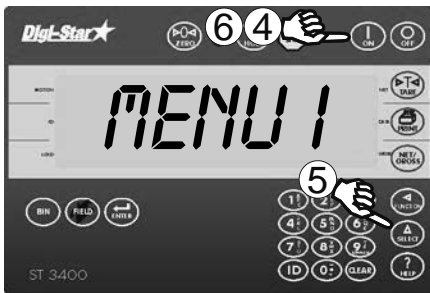

1. Press and hold **NET/GROSS** and **ON**.
2. Press **SELECT** to choose required menu.
3. Press **ON** to enter selected menu.



4. Press **ON** to scroll options.
5. Press **SELECT** to change options.
6. Press **ON** to save changes.

MENUS AND CALIBRATION

Enter Direct Access Number (D.A.N.), press  to display setting name and allows value change.

Press  to save setting.

SETTING [display]	D.A.N NO.	OPTIONS [displayed] BOLD=DEFAULT	DESCRIPTION	
MENU 1. BASIC FEATURES IN MOST INDICATORS				
LANGUAGE {LANGAG}	101	English Dutch French German Italian Portuguese Spanish Danish Hungarian Spanish	{ENGLISH} {NEDERL} {FRANCS} {DEUTSH} {ITAL} {PORT} {ESPAN} {DANSK} {MAGYAR} {VESTA}	Select language to be displayed.
DISPLAY RATE {D RATE}	102	1,2,3,4	Update display times per second.	
WEIGH METHOD {W MTHD}	105	1=General, 2=Fast, 3=Slow, 4=Lock-On, not recommended	Select weigh method.	
FIELD ID SETUP {FIELD}	108	NEW EZ	Identity of field or seed type.	
SAVE BATTERY {SRV/BAT}	111	OFF, 15, 30, 45, 60	Indicator turns off after set time.	
1 PRESS ZERO {1 ZERO}	115	ON/OFF	If ON -press and hold the Zero key to Zero/Balance scale.	
BINNUM	132	OFF, 2-10	Program number of seed tender bulk bins.	
MENU 2. CLOCK, PRINTER, COMMUNICATION FEATURES				
TIME FORMAT {TIME F}	201	24 HR AM/PM	Select time format - AM/PM or 24 hour.	
1 TIME {TIME}	202	XX:XX:XX	Select key changes time, function key chooses hh:mm:ss.	



SETTING [display]	D.A.N NO.	OPTIONS [display] BOLD=DEFAULT	DESCRIPTION
DATE FORMAT {DATE F}	203	1-mm-dd 2-mm/dd/yy 3-mm/dd/yyyy 4-dd-mm 5-dd/mm/yy 6-dd/mm/yyyy 7-ddmoyy 8-ddmoyyyy.	Select date format.
DATE {DATE}	204	Enter XXXXXX	Select key changes date -function key chooses mm/dd/yy .
ONE LINE PRINT {1L PRT}	212	ON/OFF	If ON -indicator data will be printed on one line.
PRINT FORMAT {PRTFMT}	216	PRTST1 (1 line print) PRTST3 (3 line print)	Select print format. Refer to EZIII Technical Manual for more options.
ZERO OUTPUT {ZEROUT}	219		Perform the Zero/Balance for the SCOREM #11 weight output and the analog output (4-20mA).
ANALOG LOW WEIGHT {LOW WT}	241		Enter analog weight value to equal 4mA or 0 volts.
ANALOG HIGH WEIGHT {HIGHWT}	242		Enter analog weight value to equal 20mA or 5 volts.
ANALOG SELECT {ANROUT}	243		Select 0-5V,4-20mA or 0-20mA output.
MENU 3. SCALE CALIBRATION SETTINGS			
DISPLAY COUNT {COUNT}	301	.01,.02,.05,.1,.2,.5,1,2,5,10, 20, 50,100	Select display count size of weigh values.
DISPLAY UNIT {LB-KG}	303	LB/KG	Display pounds -lb or kilograms -kg
CAPACITY {CRP}	304	40000	Enter MAXIMUM weight measurable on scale.

SETTING [display]	D.A.N NO.	OPTIONS [displayed] BOLD=DEFAULT	DESCRIPTION
MENU 4. PRESET, BATCHING & COUNTER FEATURES			
PRE ALARM <i>{P MTHD} & {P-ALM}</i>	401	WEIGHT PERCNT	Select weight or percentage method, then enter a value to activate an early warning that indicator is reaching the preset.
REMOTE INPUT <i>{RM IMP}</i>	402	MIXCTR INGRED PRESET SEEDTD	Set function of remote input line on the power cord; do not change.
ALARM OUTPUT <i>{AL OUT}</i>	403	PRESET TR Switch	Select preset to control auger; do not change.
BUZZER <i>{BUZZER}</i>	404	1-4, ON/OFF	ALARM BUZZER - allows user to turn off alarm horn.
PRELOAD TARE <i>{PRETAR}</i>	405	ON/OFF	If ON -tare weights can be entered using the numeric keypad.
RELAY	406	SEEDTD OFF STPNT PRESET PRNOPA PRACT	Enables seed tender relay; do not change. SEEDTD is default for standard seed tenders PRNOPA is default for variable throttle seed tenders
GROSS SET PNT OUTPUT <i>{SETOUT}</i>	426	SIG0V SIG12V	Polarity of output signal; Do not change
T MTHD <i>{TOLER}</i>	442	WEIGHT PERCENT	Auger offset method; do not change.
TOLERANCE <i>{TOLER}</i>	442	MANUAL ENTRY	Set tolerance weight of seed remaining in auger.
PAST	475	MANUAL ENTRY	Time for output relay to turn off: 0.00-99.9
STTHRO	478	ON/OFF	ON-enables variable throttle mode OFF- keep in standard mode

SETTING [display]	D.A.N NO.	OPTIONS [displayed] BOLD=DEFAULT CALIBRATION	DESCRIPTION
DEAD WEIGHT CAL {[CAL]}	802		Calibration method using weights.
SETUP NUMBER {[SETUP]}	871		Quick entry method selects weigh method 1-4lbs, 5-8 kg, gain 1-9, display counts 1-9 and capacity *1000.
CALIBRATION NUMBER {[CAL]}	872		Weight displayed at 0.4mV/V for these load cells.

Change Setup And Calibration Numbers



1. Enter *871* press 
2. *SETUP* briefly displays, then a 6 digit number. Enter new number.
3. Press 

Follow same procedure to change calibration number, except use *872*.

INSTALLATION

Indicator Mounting

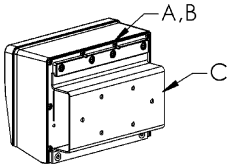

RAIL MOUNT

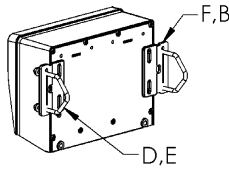

WING MOUNT

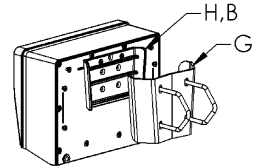

WEDGE MOUNT

KEY	PART NUMBER	DESCRIPTION
A	404353	BRACKET-EZ3 PLASTIC RAIL *
B	403780	SCR-#10 X 5/8 FHSTS BLACK ZP
C	840459	SUPPORT-HAT BRACKET
D	405069	U-BOLT 1/4-20 X 3.25 ZP
E	405084	NUT-1/4-20 TOP LOCKING FLANGE
F	403770	BRACKET- WING MOUNT *
G	405124	PACK-WEDGE MOUNT BRACKET WITH U-BOLTS & FLANGE NUTS
H	405244	EZ3 WEDGE MOUNT

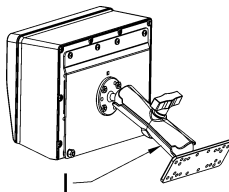

RAM MOUNT

KEY	PART NUMBER	DESCRIPTION
I	404799	RAM MOUNT FOR EZ III INDICATOR WITH HARDWARE

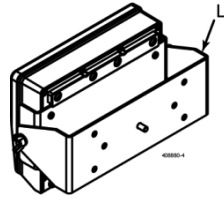
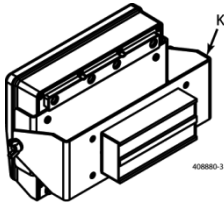

MAGNETIC SWIVEL MOUNT

KEY	PART NUMBER	DESCRIPTION
K	408880	MOUNT FOR EZ 3 INDICATOR WITH HARDWARE AND MAGNET
L	408828	MOUNT FOR EZ 3 INDICATOR WITH HARDWARE WITHOUT MAGNET



Caution

A control box is typically required for proper connection from the ST3400 to the seed tender. Improper wiring may damage the ST3400 or seed tender controls such as the radio.

Cable Connection

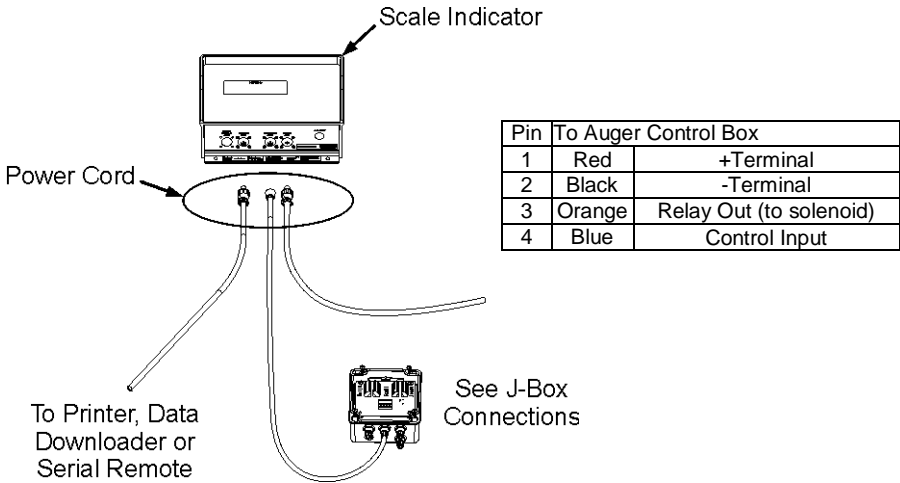

Auger Control Wiring

For standard On/Off seed tenders, refer to D3967, 408000 control box installation.

For variable throttle seed tenders, refer to D3977, 408221, and 408853 control box installation

Bottom Panel Cable Connections

Standard Connector

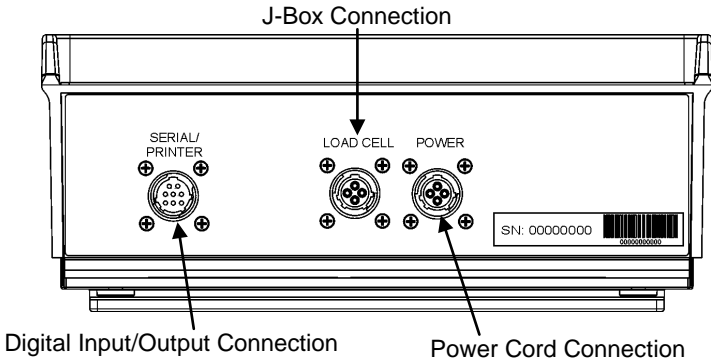

EZ Mate Connector, Optional

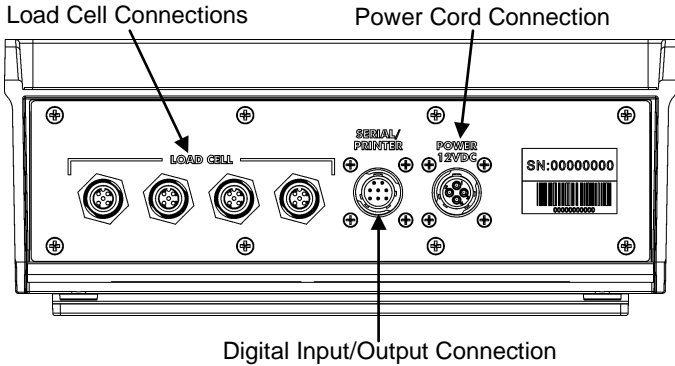

Crown Connector, Optional

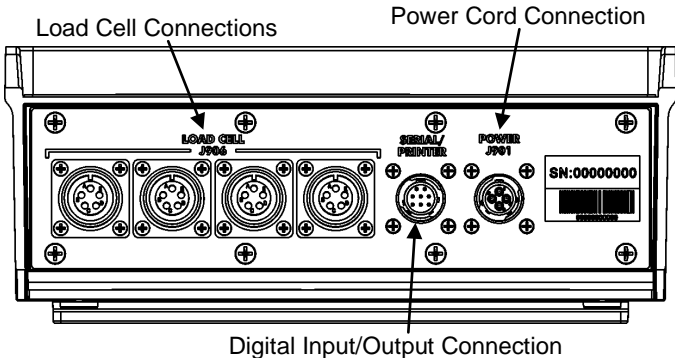

Connect Load Cells to J-Box (Standard Indicator)

Connect load cell wires to terminal blocks

Wire Color Key		
	Color	Description
1	White	Signal +
2	Green	Signal -
3	Red	Excitation +
4	Black	Excitation -
5	Shield	Shield

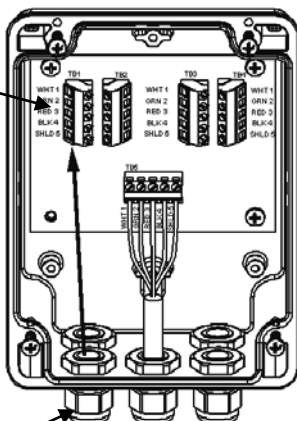

J-Box illustrated for 4 load cell installation

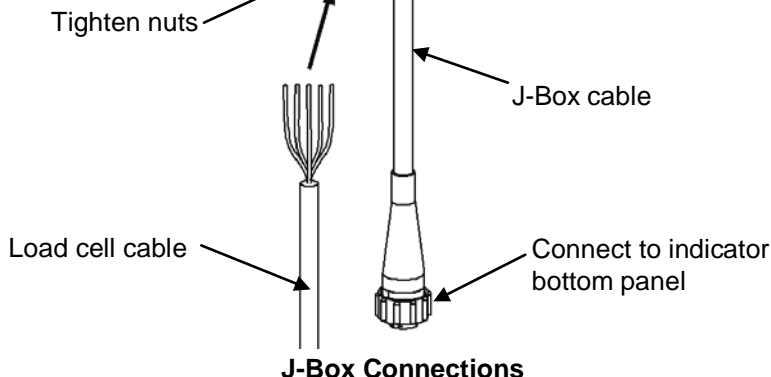

Load Cell Direction



Observe direction of arrow when installing load cell.

OPTIONAL EQUIPMENT

Transmitter/Receiver



Transmitter (shown) with factory installed receiver in indicator. Use to activate auger from remote location. Operating range about 90 feet.

NOTE: Option on standard seed tenders only. Will not function on variable throttle models

Data Transfer Options



Kit Data Down Loader

Allows transfer of data from indicator to PC.

Printer



12 Volt Printer

Connects to indicator serial port and 12VDC power.

TROUBLESHOOTING

FLOW CHART

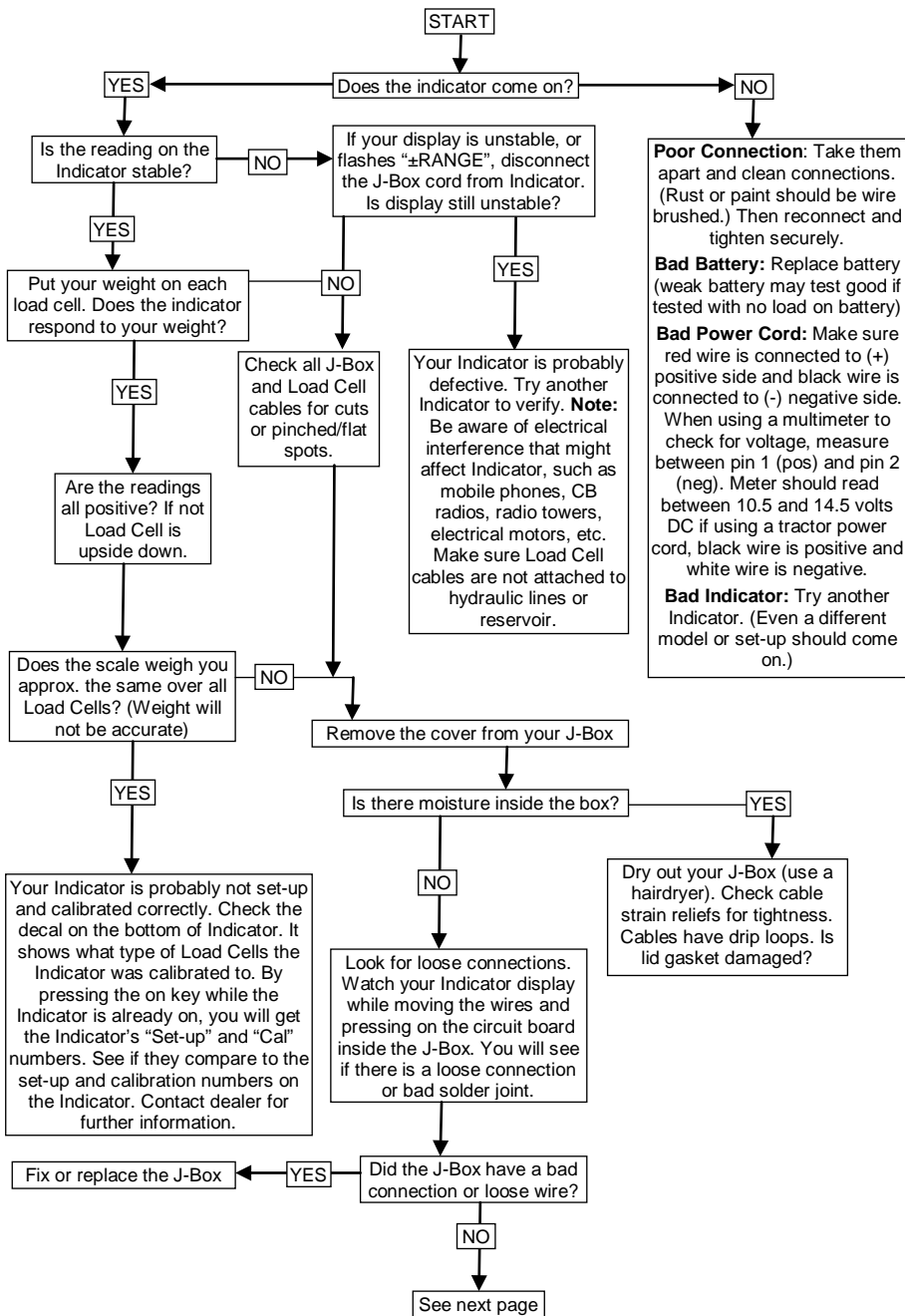

FLOW CHART

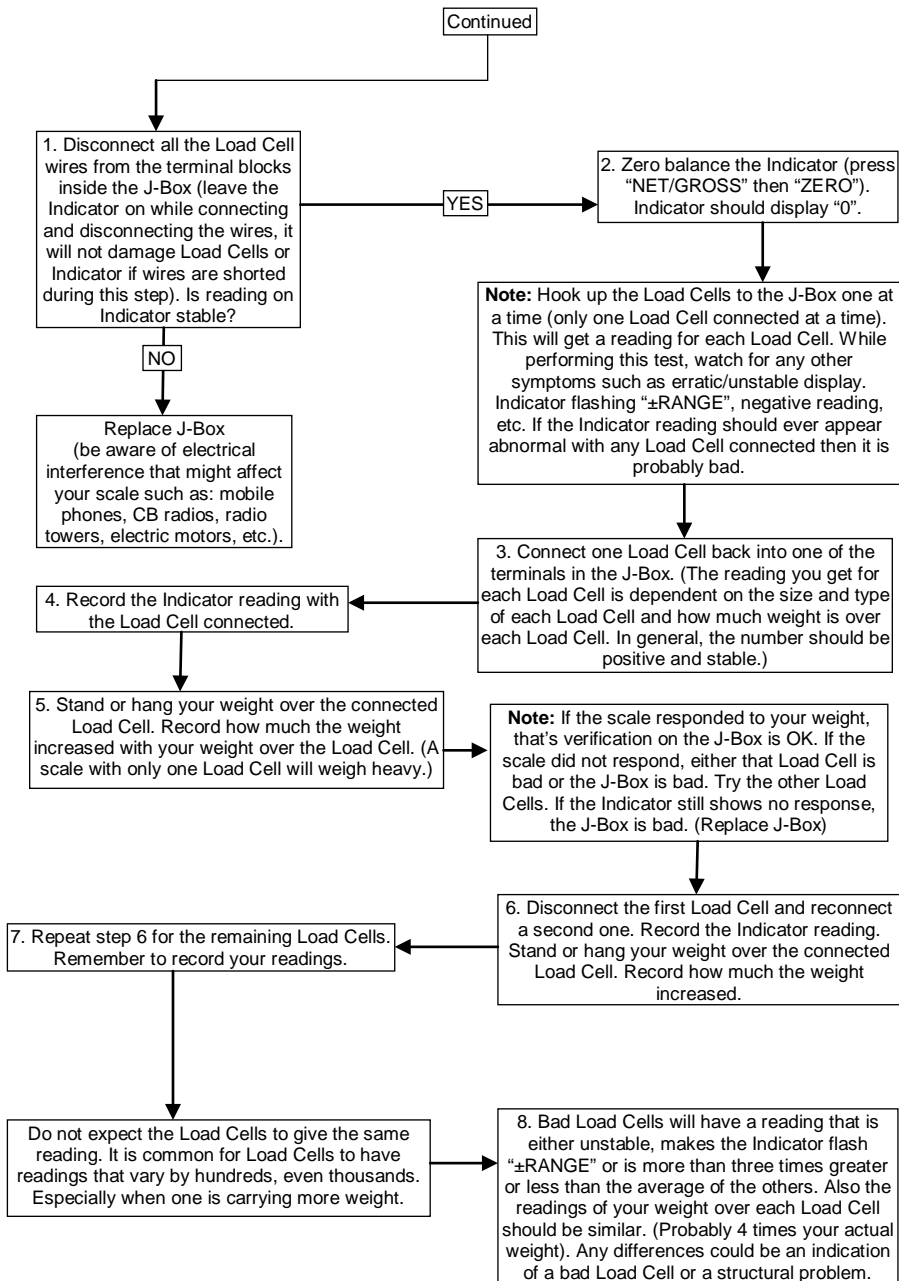

QUICK REFERENCE

MANUAL – Manual Mode

1. Verify control box switch is set to MANUAL.
2. Follow manufacturer's instructions to operate seed tender.

AUTO – Automatic Scale Mode

1. Set control box switch to AUTO.
2. Press (BIN) to select seed tender bin. Remains in TOTAL when BIN function disabled.
3. Use keypad to enter PRESET weight, press (ENTER) to store. Display will show "PRESET STORED".
4. Move seed chute to planter hopper.
5. Dispense seed to planter; hold down seed chute button if needed.
6. Auger will turn off automatically when reaching PRESET weight.
7. Repeat steps 4-6 to finish filling planter.

Auger Tolerance

Enter D.A.N. 442 to adjust auger tolerance; TOLER = entered weight value; T MTHD stays at "WEIGHT". If seed tender is dispensing too much seed, increase TOLER weight by the amount of overfill. If tender is dispensing too little seed, decrease TOLER weight.

Setting and Clearing BIN Weights

1. Press (BIN) until desired seed tender bin is displayed.
2. Enter BIN weight with keypad.
3. Press (BIN) to store weight.
4. Press and hold (ZERO) to clear BIN weight.

This Page Intentionally Blank.

This Page Intentionally Blank.

This Page Intentionally Blank.

QUICK REFERENCE

MANUAL – Manual Mode

1. Set control box switch to MANUAL.
2. Follow manufacturer's instructions to operate seed tender.

AUTO – Automatic Scale Mode

1. Set control box switch to AUTO.
2. Press (BIN) to select seed tender bin. Remains in TOTAL when BIN function disabled.
3. Use keypad to enter PRESET weight, press (ENTER) to store. Display will show "PRESET STORED".
4. Move seed chute to planter hopper.
5. Dispense seed to planter; hold down seed chute button if needed.
6. Auger will turn off automatically when reaching PRESET weight.
7. Repeat steps 4-6 to finish filling planter.

Auger Tolerance

Press 442, Enter to adjust auger tolerance; T MTHD stays at "WEIGHT"; TOLER = entered weight value. If seed tender is dispensing too much seed, increase TOLER weight by the amount of overflow. If tender is dispensing too little seed, decrease TOLER weight.

Setting and Clearing BIN Weights

1. Press (BIN) until desired seed tender bin is displayed.
2. Enter BIN weight with keypad.
3. Press (BIN) to store weight.
4. Press and hold (ZERO) to clear BIN weight.

✂ Cut here ✂