

DIGI★STAR

P R E C I S E L Y

GT460 AutoLog₂ Operators Manual



DIGI★STAR

P R E C I S E L Y

Ft. Atkinson, Wisconsin USA

Digi-Star International
Panningen, The Netherlands
www.digi-star.com

Thank you for the purchase of a GT460 indicator. With optional equipment, it is the simplest most flexible system on the market today. With proper operation and preventative maintenance it will last for years.

The Digi-Star GT460 is designed for use weighing, tracking, storing, and transferring related data regarding the weight of agricultural grains, forages, and other commodities on mobile weigh wagons, grain carts, forage boxes, and other agricultural conveyances.

The data collected by, and transferred from, the GT460 is designed primarily for use with Digi-Star's Grain Tracker™ and Forage Tracker™ software. For maximum value from the GT460 indicator, Digi-Star recommends that Grain Tracker™ / Forage Tracker™ software program be loaded on a PC. This program will allow the full initialization and personalization of the indicator to the operation. The manual for this software program is found within the program under the help tab.

The GT460 is not for use with applications for which the GT460 is not intended, or as outlined in this manual.

Use of the GT460 outside of its intended purposes may result in inaccurate weight measurement or damage to instrument.

D3804-US-GT460 Rev E- SCC

All rights reserved. Reproduction of any part of this manual in any form whatsoever without Digi-Star's express written permission is forbidden. The contents of this manual are subject to change without notice. All efforts have been made to assure the accuracy of the contents of this manual. However, should any errors be detected, Digi-Star would greatly appreciate being informed of them. The above notwithstanding, Digi-Star can assume no responsibility for errors in this manual or their consequence.



© Copyright! 2014 Digi-Star, Fort Atkinson (U.S.A.).

Table of Contents

GT 460 FEATURES & OPTIONS	4
ACCURACY STATEMENT	5
DECLARATION OF CONFORMITY	6
INDICATOR OVERVIEW	7
ACTIVE SCREEN	10
DATA RECORD SCREEN.....	11
FIELD SCREEN	12
ID SCREEN.....	13
Edit Truck Capacity	14
TRANSFER DATA	15
Transfer Field & ID Data from USB to Indicator.....	15
Transfer Records from Indicator to USB Drive	16
OPERATION	17
Turn On Indicator	17
Record Data - Automatic Mode (With AutoLog ₂)	17
Record Data – Manual Mode (Without AutoLog ₂)	18
Recorded Data Preview	18
Check Combine Yield Monitor	19
AUTOLOG ₂	20
RE-CALIBRATING THE SCALE.....	23
Get your Calibration Number	24
DAILY DATA COLLECTION.....	26
Modify Field Names and ID	27
Clearing the Indicator Memory before Starting a Season.....	27
Erase Grain Tracker™ Data Records	28
Zero Accumulator Memory	28
OPTIONAL SETTINGS.....	29
Backlight Dimmer	29
Unload Alarm.....	29
Change Time.....	30
Change Date	30
SETTING OPTIONS	31
Preset Active Signal Functionality	35
12VDC Output Diagrams.....	37
WEIGHING ERROR MESSAGES.....	42
OVRCAP	42
+RANGE	42
-RANGE	42
INSTALLATION.....	43
Cable Connection.....	44
Connect Load Cells to J-Box.....	45
AUTOLOG ₂ TROUBLESHOOTING	46
RPM Sensor Diagnostics	46
Verify AutoLog ₂ Settings.....	47
CHARGING BATTERY OR WELDING	48

GT 460 FEATURES & OPTIONS

Hands Off (AutoLog₂) Operation

The GT 460 indicator has many features but it also boasts simple hands-off operation using a RPM sensor on the PTO shaft to trigger the start of the unloading process and the end of the unloading process. AutoLog₂ aids in preventing operator mistakes and loss of load data due to the operator forgetting to push the  key. Manual control using the  key is possible should the sensor be damaged or not functioning by disabling AutoLog₂. See page 18 for instructions. Weight, date, time and additional information is stored automatically after each load is completed.

AutoLog₂

AutoLog₂ is an optional function which allows the operator to set weight targets when unloading. The indicator will sound an alarm and/or activate a control signal when the preset unload weight is met.

There are 3 methods available to control the targeted unloaded weight.

1. Weight set per Truck ID - Each truck with a stored ID can have a preset weight. Useful when working with trucks of various capacities.
2. Stored Target Weight - When the same amount is unloaded each time. The stored weight repeats until changed. Useful when all trucks have the same capacity.
3. Load by Load - With each unloading event the GT460/465 will prompt the operator to enter the required weight to unload. Useful when flexibility is required.

USB Port

USB drive has capacity to hold thousands of data records and allows easy data transfer.

Grain Tracker™ or Forage Tracker™

Grain Tracker™ or Forage Tracker™ software provided with GT 460 indicator allows generation of a variety of reports. Reports can be read by programs such as Microsoft Excel™, Adobe Acrobat™ and Microsoft Internet Explorer™.

ACCURACY STATEMENT

ACCURACY:**READ THIS SECTION BEFORE USING THE SCALE SYSTEM**

DIGI-STAR SCALE SYSTEMS ARE MANUFACTURED TO PROVIDE THE GREATEST ACCURACY POSSIBLE. HOWEVER PROPER DESIGN, INSTALLATION AND USE ARE REQUIRED IN ORDER TO OBTAIN THE HIGHEST LEVEL OF ACCURACY.

WHEN USING THE SCALE SYSTEM THE FOLLOWING MUST BE CONSIDERED IN ORDER TO REALIZE THE BEST POSSIBLE PERFORMANCE AND ACCURACY.

- LOAD CELLS MUST BE INSTALLED WITH THE PROPER ORIENTATION. MOST DIGI-STAR LOAD CELLS HAVE A LABEL INDICATING EITHER THE "TOP" OR BENDING DIRECTION OF THE LOAD CELL. INSPECT LOAD CELLS TO DETERMINE IF INSTALLATION IS CORRECT. INSTALLATION OF ANY LOAD CELLS WITH THE ORIENTATION INCORRECT WILL RESULT IN INACCURATE MEASUREMENT.
- LOAD CELLS SHOULD NOT BE SUBJECTED TO ANY STRAINS OR LOADS OTHER THEN THE WEIGHT OF THE LOAD. STRESS OR STRAIN CAUSED BY MISALIGNMENT OR OTHER FACTORS WHEN ACCURATE WEIGHT READINGS ARE DESIRED WILL NEGATIVELY AFFECT THE ACCURACY.
- THE WEIGHING UNIT SHOULD BE STATIONARY, WITH MINIMAL MOVEMENT, AND ON A LEVEL SURFACE TO INSURE THAT WEIGHT READINGS ARE AS ACCURATE AS POSSIBLE.
 - THE AFFECT OF MOVEMENT ON ACCURACY DEPENDS ON THE SPEED AND ROUGHNESS OF THE GROUND AND APPLICATION. ROUGHER TERRAIN AND FASTER AND/OR GREATER MOVEMENT INCREASES THE DEGRADATION OF ACCURACY.
 - A LEVEL SURFACE IS DEFINED AS BEING LESS THAN A 5" (13cm) CHANGE IN RISE OVER 10' (3.0m) OF RUN. AS THE SLOPE OF THE TERRAIN INCREASES, DEGRADATION OF ACCURACY WILL ALSO INCREASE.

DECLARATION OF CONFORMITY

EMC DECLARATION OF CONFORMITY

Application of Council Directive(s) 2004/108/EEC

Manufacturer's Name: Digi-Star, LLC

Manufacturer's Address: 790 West Rockwell Avenue
Fort Atkinson, WI 53538

European Representative Name: Digi-Star Europe, B. V.

European Representative Address: J.F. Kennedylaan 235
5981 WX Panningen
The Netherlands

Model Name: GT460, 510, NT460

Conformance to:

- EN 61326 electrical equipment for measurement, control, and laboratory use (See Report Number TR-9870.)
- EN 55011, for Class B ISM equipment for industrial, scientific, and medical equipment. (See Report Number TR-9870.)

Equipment Type/Environment: Electronic weighing scale systems; not legal for trade.
For agricultural, commercial and light industrial.

Beginning Serial No.: 1001

Year of Manufacture: 2009

We, the undersigned, hereby declare that the equipment specified above conforms to the above Directive(s).

Manufacturer



Signature

Full Name: Doug Evenson
Position: Director of Operations
Place: Fort Atkinson, WI U.S.A.
Date: March 25, 2009

Legal Representative in Europe







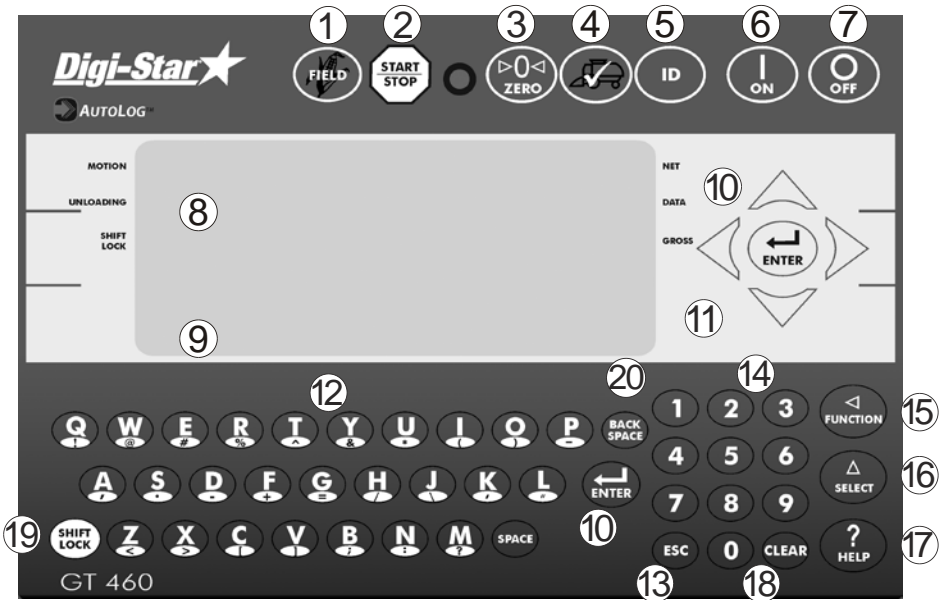

Signature

Full Name: Wim de Wit
Position: Managing Director
Place: Panningen, The Netherlands
Date: March 25, 2009

INDICATOR OVERVIEW



- ① **FIELD** – Enter and exit Field screen (Page 12).
- ② **START STOP** – Start or stop unloading operation.
- ③ **ZERO** – Press and hold to zero balance the scale.
- ④ **Yield Monitor** – Check combine yield monitor (Page 19).
- ⑤ **ID** – Enter and exit ID screen.
- ⑥ **ON** – Turn indicator on.
- ⑦ **OFF** – Turn indicator off.
- ⑧ Upper Display Window – Displays current actions or weight – 6 characters.
- ⑨ Lower Display – Displays recorded data – 26 characters x 3 rows.
- ⑩ **ENTER** – Accept change or proceed to next item.

- ⑪ Directional Arrows – Left or right arrows move cursor inside data field. Up and down arrows move to previous or next data field. List scrolls faster the longer the Up/Down arrow is held down.
- ⑫ Qwerty Keyboard
- ⑬  – Escape or undo last data change.
- ⑭ Numbers Keypad
- ⑮  – Performs task displayed by select.
- ⑯  – Scroll thru function key operation.
- ⑰  – For additional information.
- ⑱  – Delete one character in data entry field. Press and hold to delete entire data entry field contents.
- ⑲  – Press and release. Then press key with desired special character.
- ⑳  - Press to backspace. Press and hold to backspace faster.

BOTTOM PANEL CONNECTIONS

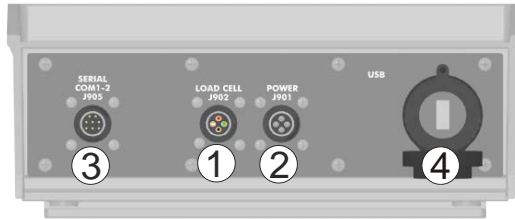

- ① Load Cell
- ② Power – 12VDC
- ③ Serial/Printer – Used to communicate with computer, data downloader (DDL) or printer.
- ④ USB – Port for USB drive

INDICATOR DISPLAY SCREENS

Four display screens can be shown on the Indicator:

Active Screen

Statistics including ID, Time, Gross Weight, Print Accumulator and Field Name. See page 10.

Data Record Screen

Data records including Field Name, Net Weight, Print Accumulator, ID, Date and Time. See page 11.

Field Screen

150 field names are available and can be modified using the keypad. See page 12.

ID Screen

150 ID names are available and can be modified using the keypad. See page 13.

ACTIVE SCREEN

Indicator needs to be on this screen before loading or unloading.



- ① Current weight.
- ② Current ID name.
- ③ Current gross weight.
- ④ Current field name.
- ⑤ Time (3:33 PM shown).
- ⑥ Print accumulator (PA) for current field.

DATA RECORD SCREEN

The indicator creates “**data records**” containing these data fields each time the operator completes a load.

- Press **ESC** to view last stored record.
- Press **▲** or **▼** to scroll through all previously stored records.



- ① Load Number.
- ② Field name (26 characters).
- ③ Weight (weight that was unloaded for this load).
- ④ ID name (6 characters) (Use for CART ID or TRUCK ID).
- ⑤ Date (November 24, 2008 shown).
- ⑥ Time (5:34 PM shown).
- ⑦ Accumulated weight (total of all loads for selected field).

Note: This screen is shown for only 10 seconds before reverting to the Active screen.

FIELD SCREEN

- Field names can be uploaded from a PC using a USB drive. See page 15.
- Field names can be a maximum of 26 characters long.
- Field names can be changed using the keypad before unloading.

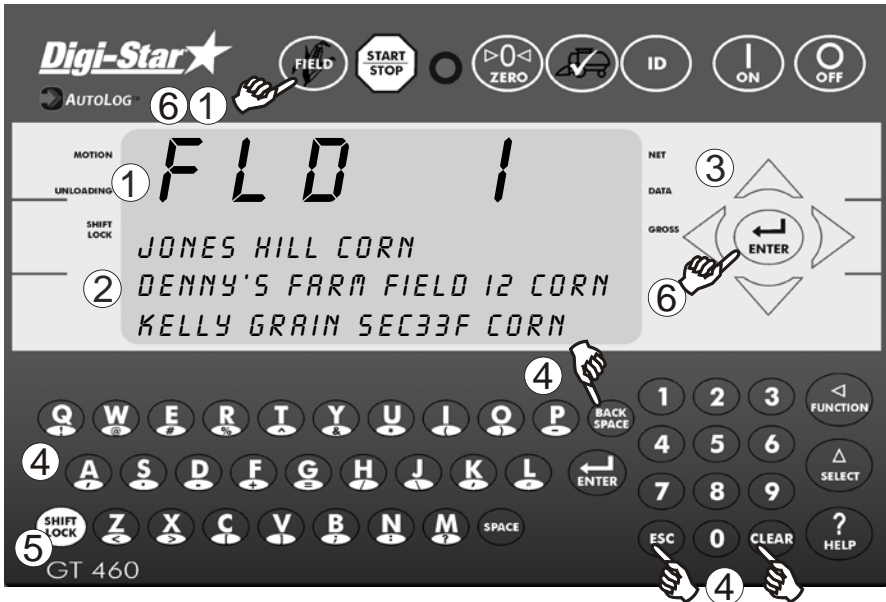



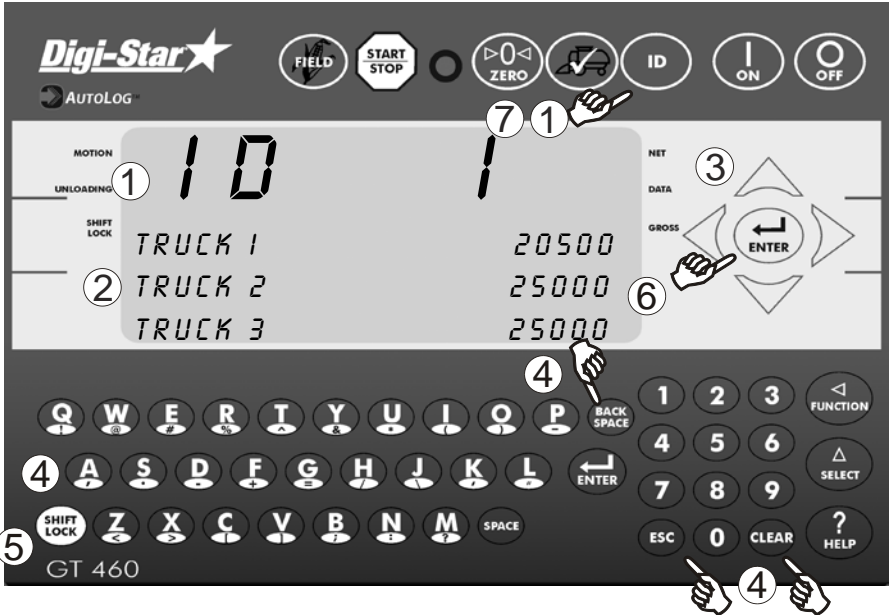

- ① Press **FIELD** to modify or select field. Current field number is shown in upper display.
- ② Three lines are displayed in Lower Display Window. The top line of the three is current, editable and will be used for next data record.
- ③ Up/Down Arrows – Press or to scroll through fields (150 maximum). Hold arrow to scroll faster. Use or to move cursor within data line.
- ④ Use keypad to enter or update field names. Press **BACK SPACE** to delete characters to left and **CLEAR** to delete the selected character. Hold **CLEAR** to delete entire line. Pressing **ESC** will reset line to last saved data.
- ⑤ To use special characters press and release **SHIFT LOCK**. Then press key with desired special character. Repeat for each special character required.
- ⑥ Press **ENTER** or **FIELD** to exit.

ID SCREEN

- Auto Load Preset (**ALP** – D.A.N. 477) must not be set to OFF.
- ID names can be uploaded from a PC using a USB drive. See page 15.
- ID names and capacities can be a maximum of 6 characters long.
- ID names can be changed by using the keypad before unloading.
- ID Screen has two columns with ID on left and capacity on right of 3 line display



- ① Press **ID** to modify or select ID name. Current ID number is shown in upper display.
- ② Three lines are displayed in Lower Display Window. The top line of the three is current, editable and will be used for next data record.
- ③ Up/Down Arrows – Press or to scroll through ID names (150 max.). Hold arrow to scroll faster. Use or to move cursor within data line.
- ④ Use keypad to enter or update ID names. Press **BACK SPACE** to delete characters to left and **CLEAR** to delete the selected character. Hold **CLEAR** to delete entire line. Pressing **ESC** will reset line to last saved name.
- ⑤ To use special characters press and release **SHIFT LOCK**. Then press key with desired special character. Repeat for each special character required.

- ⑥ The operator will see ID XXX while editing the ID and CAP XXX while editing the capacity. After editing the ID press  to move the cursor to capacity field to enter capacity data. The display will scroll to the next ID when pressing  or .
- ⑦ Press  or  to exit.

Edit Truck Capacity

GT460's running software version 9B or later has the ability to add and edit truck capacities. GT460's running software versions earlier than 9B can be updated with new software and the necessary hardware to provide this functionality. Contact Digi-Star Support at 1-800-225-7695 for details.

Updated Grain Tracker software allows entering and editing of truck capacities on the PC and then transferring the setting to the GT460 Indicator.

Using the ID screen explained above, the operator can select not only the stored preset for unloading, but also either automatically use the truck capacity for the current ID or prompt the operator to either edit or accept the truck capacity before unloading.

AutoLog₂-Auto Load Preset (ALP – D.A.N. 477) has 4 selections; **OFF**, **STORED**, **TRUCK**, **AND PARTCP**

OFF - No output control will be activated and the preset will not be used.

STORED - The operator manually enters a preset in the main weight screen and when unloading begins, by manually pushing the START/STOP or AutoLog₂ activates, the preset will be displayed and used for the control of the output signal.

TRUCK - The current ID truck capacity will automatically be used when unloading begins. This operation is similar to loading a stored preset, but the operator will see the actual capacity from the ID screen when the unloading process begins instead of a previously entered preset.

PARTCP – This selection allows the operator to edit the preset to be used for unloading. When unloading begins the operator will see the truck capacity on the six character display. This amount can be editing using the front panel keys or it can be accepted by the operator by pressing . The **PARTCP** prompt is intended to represent PARTIAL CAPACITY.

TRANSFER DATA



The indicator is equipped with a USB drive port. The USB drive used with the indicator holds thousands of data records and allows for easy transfer to PC.

Transfer Field & ID Data from USB to Indicator



1. Insert USB drive. Indicator will automatically detect the USB drive.



2. Press 9 to transfer field names and ID names from USB drive to indicator.
3. Press **ESC** to exit. Remove USB drive from socket. Display returns to active screen.

Important: This action will overwrite Field names, ID names and Accumulator in the indicator.

Transfer Records from Indicator to USB Drive



1. Press  to save records to USB drive.

Note: This action appends values already on the USB drive. No data is lost.

OPERATION

Turn On Indicator



1. Press **ON**
2. Press and hold **ZERC** to zero balance scale if the bin is empty.

Record Data - Automatic Mode (With AutoLog₂)

Note: To operate GT460 with AutoLog₂ the GT460 must be connected to a PTO speed shaft sensor. In addition, the GT460 AutoLog₂ functionality must be turned on. Check that D.A.N. 531 is set to ON. See page 34.

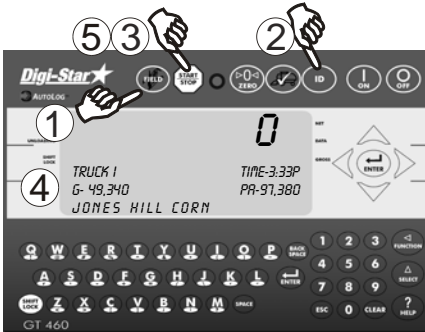

1. Press **FIELD** to select required field name. See page 12.
2. Press **ID** to select required ID. See page 13.

Note: Make sure Indicator has returned to the active screen.

3. If AutoLog₂ is enabled, simply start the PTO. Scale will read Zero and enter the net mode.
4. Unload grain from grain cart. The Upper Display shows the amount unloaded. Gross value (total amount left on cart) is displayed on second line of Lower Display.
5. If AutoLog₂ is enabled, simply stop the PTO. Data record will be stored, displayed and printed.

NOTE: If AutoLog₂ is not working correctly, see page 46 for troubleshooting and set-up instructions.

Record Data – Manual Mode (Without AutoLog₂)

Note: If the GT460 is not fitted with a PTO shaft speed sensor the Indicator must be operated in the Manual mode. See pages 31-34.

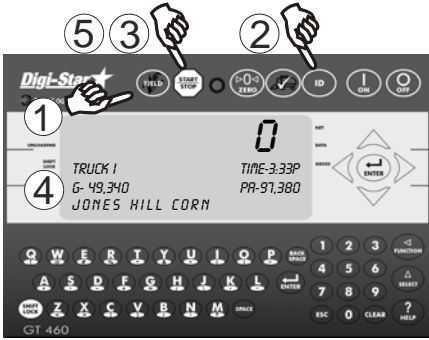

1. Press **FIELD** to select required field name. See page 12.
2. Press **ID** to select required ID. See page 13.

Note: Make sure Indicator has returned to the active screen.

3. Press **START/STOP** before unloading grain from cart. Scale will read Zero and enter the net mode.
4. Unload grain from grain cart. The Upper Display shows the amount unloaded. Gross value (total amount left on cart) is displayed on second line of Lower Display.
5. Press **START/STOP** once the unloading process is complete.

When the unloading process is complete:

- The data record is stored in memory.
- The data record is printed.
- The data record screen will display the last data record for 10 seconds.

The indicator will return to active screen.

Recorded Data Preview

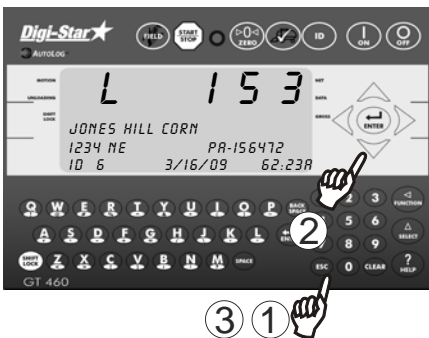

1. Press **ESC** to see last data record.
2. Press **▽** or **△** to scroll record data.
3. Press **ESC** to immediately return to the active screen. After 10 seconds of no keypad activity, the Indicator will return to the active screen.

Check Combine Yield Monitor

For best accuracy, park on a level surface when pressing .



1. Press .
2. Bottom line displays *WEIGH COMBINE GRAIN*.
3. Select ID Name. See page 13.



4. Press  and unload grain into cart. Press again when unloading is complete to record data.

AUTOLOG₂

AutoLog₂ functionality is designed to provide assistance controlling the amount of grain unloaded from the grain cart or wagon. The operator can set weight targets to unload. The GT460 indicator will sound an alarm and/or activate a control signal to operate a switch or solenoid when the preset unload weight is met.

There are 3 methods available to control the targeted unloaded weight.

1. Weight set per Truck ID - Each truck with a stored ID can have a preset weight. Useful when working with trucks of various capacities.
2. Stored Target Weight - When the same amount is unloaded each time. The stored weight repeats until changed. Useful when all trucks have the same capacity.
3. Load by Load - With each unloading event the GT460/465 will prompt the operator to enter the required weight to unload. Useful when flexibility is required.

Once set, preset control is activated by the AutoLog₂ functionality or by the START/STOP button.

In addition AutoLog₂ provides additional functionality by allowing maximum capacities of individual trucks to be stored in the GT460 Indicator as part of the ID functionality. See page 13 for details.



See page 35 for additional details for using the Preset Active Signal Functionality connected with setting the preset weight option below.

To enable AutoLog₂ and its options



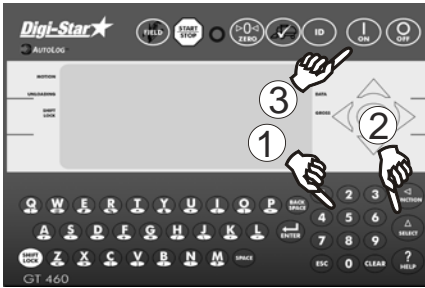

1. Enter 477 then press **SELECT**.
2. Press **SELECT** again to change ALP setting to option other than "OFF".
3. Press **ON** to store. This setting allows preset weight values to be entered with the keypad, so that the GT460 can control other functions based on a target weight. Turn this setting OFF for normal grain cart mode.



1. Enter 406
2. Press  to change the RELAY function.
3. Press  to store.





The RELAY function defines what function the GT460 performs when the preset weight is activated during the unloading process. This can be held at 12 VDC while the preset is active (PRACT), or activate 12 VDC once the preset weight is reached during unloading (PRNOPA).



1. Enter 475
2. Press 
3. Enter time for PAST setting, if needed.
4. Press  to store.

The PAST setting is the time (0.0 to 99.9 seconds) for the RELAY function to timeout. If RELAY is set as PRACT and is held at 12 VDC output during the entire unload process, this setting extends the time at which the relay remains at 12 VDC output. If RELAY is set as PRNOPA and activates 12 VDC output at the end of the unload cycle, this setting determines how long the output stays on after the target weight is reached.



1. Enter 442
2. Press 
3. Press  to choose WEIGHT or PERCNT; WEIGHT is preferred choice for this application.
4. Press  to store.
5. Type in TOLER value.
6. Press  to store.
This is normally the weight value of grain still unloading; set to help prevent overfilling the truck. If the implement unloads by 1000 pounds too high each time, the TOLER value should be set to 1000.
7. Enter preset weight to be unloaded.
8. Press 
If 5000 pounds is entered, this is the range at which the relay functions above will activate.

Example Application 1: Grain cart with GT460 AutoLog₂ system is to activate an external alarm light to notify truck driver that cart is unloading. Truck is allowed to hold 40,000 pounds. Grain cart operator opens and closes doors, and wants to make sure an additional 30 seconds are allowed for cleanout before truck drives away.

Set 477 ALP to ON. Set 406 RELAY to PRACT. Set 475 PAST to 30.0. Press 40000 then ENTER to store preset weight value. Connect green DC Output wire to external alarm light +12V, black to - /Ground.

Operation: Start PTO, GT460 automatically loads 40,000 pound preset, external alarm light flashes for truck driver. Open door to unload grain, then close door when near 40,000 pounds. Target weight is reached; 30 second delay time begins to give cart operator time to clean out auger and turn off PTO. After 30 seconds, external alarm light turns off, data is logged, and truck drives away.

Example Application 2: Grain cart with GT460 AutoLog₂ system is to activate an alarm in tractor cab for 10 seconds to notify operator once 35,000 pounds is unloaded, so that the door can be closed. The operator has a history of overloading the truck by 5000 pounds each time.

Set 477 ALP to ON. Set 406 RELAY to PRNOPA. Set 475 PAST to 10.0. Set 442 to WEIGHT; TOLER to 5000. Press 35000 then ENTER to store preset weight. Connect green DC Output wire to alarm +12VDC, black to ground.

Operation: Start PTO, GT460 automatically loads 35,000 pound preset. Open door to unload grain. Target weight is reached 5000 pounds early, sounding alarm for operator to close the door. The preset is deactivated at 30,000 pounds to correct for overfill, and the data is logged when the PTO is stopped.

RE-CALIBRATING THE SCALE

To re-calibrate the scale and make it even more accurate, document at least 3 to 6 loads of varying sizes and measure the actual weight of all loads on a certified scale.

- It must be assured that each truck is not losing grain in transit to a certified scale.
- Weigh the truck immediately before unloading and immediately after unloading to minimize errors due to changes in fuel etc.

In this example, six carts of grain are unloaded into four semi-trucks.

Example:

Cart Load A	51560
Cart Load B	33240
Cart Load C	17620
Cart Load D	50420
Cart Load E	38200
Cart Load F	12360
Total Indicator Weight	203400

Truckload #1	51920
Truckload #2	51320
Truckload #3	50720
Truckload #4	51070
Total Certified Weight	205030

Enter New Calibration Number



1. Enter **872**
 2. Press **SELECT** .
- Existing calibration number will display.
3. Enter new number
 4. Press **ENTER** .

For best results, unload on level ground. Make sure no grain is lost in trucking the grain to a certified scale.

DAILY DATA COLLECTION

Insuring data is secure from theft, fire or equipment failure requires a small effort each day to store data on a USB drive.

Mid-Season Name Changes

During the season, you may wish to delete and add field names or ID names to the scale indicator memory. This may be done in one of two ways.

Front Panel

For a small number of changes, edit field names and ID names using the keypad on the front panel. See page 12 and 13 to edit field names and ID names. See page 27 to erase accumulator memory.

Upload New Field Names, ID Names and Accumulator Using USB Drive

For a large number of changes, perform the changes on your PC using Grain Tracker™ or Forage Tracker™ software and then transfer the new information to the indicator using a USB drive.

Note: Before making any changes to field entries always transfer your existing field accumulator data from the indicator to the USB drive and onto your PC. This keeps the proper accumulator values on partially finished fields.

To Store Data Records on a USB Drive

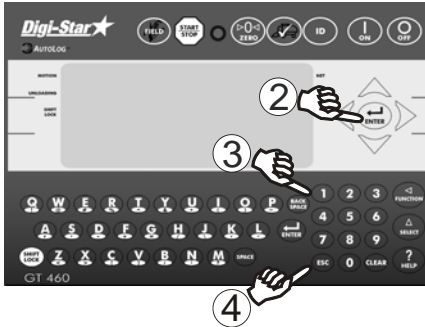

1. Insert a USB drive into the USB port on the bottom of the indicator. Wait for the indicator to acknowledge the USB drive.
2. Press **ENTER** to transfer the data record onto the USB drive. Wait for data transfer to be completed.
3. Press **1** to transfer the field and ID names onto the USB drive. Wait for data transfer to be completed.
4. Press **ESC**.
5. Remove the USB drive from the USB port.

Modify Field Names and ID

Using Grain Tracker™ or Forage Tracker™ software:

- Upload data records from USB drive to PC.
- Delete field names that are already finished and clear their accumulators.
- Add new field names as needed.
- Transfer the new field names, accumulators and ID names onto the USB drive.

Note: To upload data to indicator, you must first create data files with field names, ID names and accumulator values using Grain Tracker™ or Forage Tracker™ software.

Clearing the Indicator Memory before Starting a Season

Before starting the harvest each year, delete previous year's data records and accumulators. This is also a good time to add and store new field and ID names.

Important: Before erasing the data records, be sure that the data records have been safely stored.

Erase Grain Tracker™ Data Records

Important: This action will erase all data records.

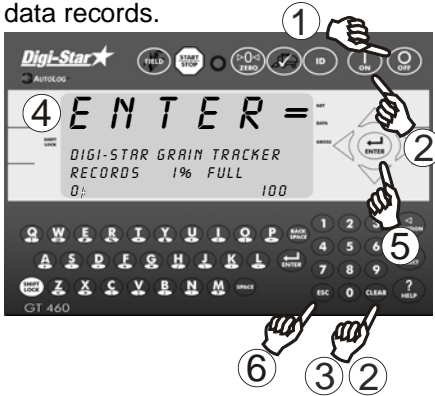

1. Press **OFF**.
2. Hold **CLEAR** and press **ON**. Continue to hold **CLEAR** until **PRINT BUFFER** displays.
3. Release **CLEAR**.
4. Display scrolls **ENTER = ERASE**
ESC = EXIT.
5. Press **ENTER** erases all records.
6. Press **ESC** to return to active screen without erasing records.

Zero Accumulator Memory



1. Select field name of accumulator to be erased. See page 12. Return to the active screen.
2. Press **SELECT** repeatedly until **ACCUM** is displayed.
3. Press **FUNCTION**.
4. Press **ZERO** deletes current field accumulated value, press **FIELD** erases all 150 accumulated records.
5. Press **ESC** to exit.

Note: This operation only erases the accumulator data, field names. ID names and data records are not affected.

OPTIONAL SETTINGS

Backlight Dimmer



1. Press **SELECT** until dimmer is displayed.
2. Press **FUNCTION** reduces backlight intensity by 60%. Press **FUNCTION** again for full intensity.

Unload Alarm

The unload alarm beeper can be set to:

- Off – no beep
- 1 – short beep
- 2 – medium beep
- 3 – medium long beep
- 4 – longest beep

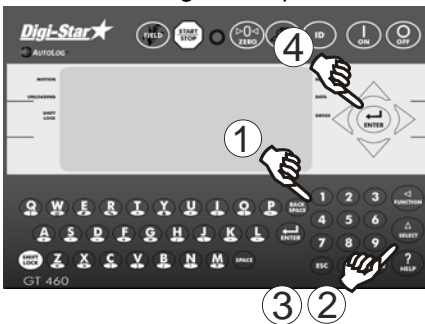



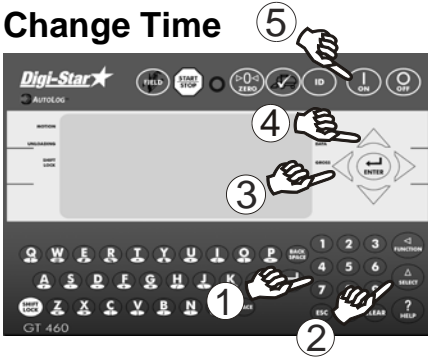

To change unload alarm:
In the active screen:

1. Enter **407**
2. Press **SELECT**
3. Press **SELECT** until desired setting is shown.
4. Press **ENTER** to save setting and return to active screen.





Change Time

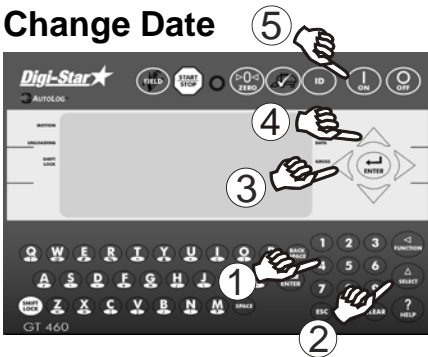

1. Enter **202**
2. Press 
3. Press  arrow to move cursor.
4. Press  to set time.
5. Press 



Change Date





1. Enter **204**
2. Press .
3. Press  arrow to move cursor.
Format ddmmyy.
4. Press  arrow to set date.
5. Press 

SETTING OPTIONS

To modify options in following chart, while on the active screen:

1. Enter D.A.N. (Direct Access Number) and press  to enter selected option.
2. Press  repeatedly until desired selection is shown.
3. Press  to set.

SETTING [display]	D.A.N NO.	OPTIONS [display] BOLD=DEFAULT	DESCRIPTION
MENU 1. BASIC FEATURES IN MOST INDICATORS			
Language (LANGAG)	101	English (ENGLISH) Dutch (NEDERL) French (FRANCS) German (DEUTSH) Italian (ITAL) Portuguese (PORT) Spanish (ESPAÑ) Danish (DANSK) Hungarian (MAGYAR) Spanish (VESTA)	Select language to be displayed.
Display Update Rate (D-RATE)	102	1,2,3,4	Update display times per seconds.
Motion Arrow (MOTION)	103	ON/OFF	Arrow flashes for unstable weight.
Zero Tracking (ZTRACK)	104	ON/OFF	Set to OFF.
Weigh Method (W MTHD)	105	1=General, 2=Fast, 3=Slow, 4=Lock-On	Use general.

SETTING [display]	D.A.N NO.	OPTIONS [display] BOLD=DEFAULT	DESCRIPTION
Scroll (SCROLL)	118	0,1,2,3, 4 ,5,6,7,8,9	Sets scroll rate of Display.
MENU 2. CLOCK, PRINTER, COMMUNICATION & ESTIMATED WEIGHT FEATURES			
Time Format (TIME F)	201	24 HR AM/PM	24-hour time format.
Set Time (TIME)	202	XX:XX:XX	Use  increments each digit and use "ARROW" keys advances cursor to set date "mmdyy" field.
Date Format (DATE F)	203	1, 2 ,3,4,5,6,7,8	Select date format. 1 = mm – dd 2 = mm/dd/yy 3 = mm/dd/yyyy 4 = dd/mm 5 = dd/mm/yy 6 = dd/mm/yyyy 7 = dd/mm/yy 8 = dd/mm/yyyy
Set Date (DATE)	204	Enter XXXXXX	 changes date, "ARROWS" advance cursor to set date.
One Line Print (1L PRT)	212	ON/OFF	Formats printer output to one line.
Computer in Mode (COM IN)	215	DOWNLD , EZ CMD, EZ2CMD	DOWNLD = Data Down Loader, EZ CMD = Original EZ Commands, EZ2CMD = EZII Escape Commands.
Print Format (PRTFMT)	216	PRTAC5	Use PRTAC5.
Media Type (MEDIA)	217	DDL , Datakey, Serial PC	Select data storage type
Com 1 Delay (CI DLY)	221	OFF ,.10,.25,.50, .75,1-5	Printer delay. Set to higher number for slow printing.

SETTING [display]	D.A.N NO.	OPTIONS [display] BOLD=DEFAULT	DESCRIPTION
Print Accum. (<i>ACCUM</i>)	223	0	Shows a running total of weights printed.
BUFFER (<i>BUFFER</i>)	238	ON	Set to ON
PBLine (<i>PBLINE</i>)	239	1, 2, 3	Scroll through memory lines at a time.
MENU 3. SCALE CALIBRATION SETTINGS			
Display Count (<i>COUNT</i>)	301	.01,.02,.05,.1,.2,.5, 1,2,5, 10 ,20, 50,100	Minimum weight change that is displayed. Note: If this is too small, scale will be unstable.
Display Unit (<i>LB-KG</i>)	303	LB/KG	Unit of measure. Note: If this changes, calibration and set-up must change.
Capacity (<i>CAP</i>)	304	85,000	Maximum capacity of scale.
MENU 4. PRESET, BATCHING & ROTATION COUNTER FEATURES			
Relay (<i>RELAY</i>)	406	OFF , SETPNT, PRESET,SEEDTD, PRNOPA, PRACT (D.A.N. 477 must <u>not</u> be set to OFF for these options to work)	Selects behavior for the +12VDC output. OFF= No output sent SETPNT= weight at which output is on or off PRESET= see page 35 SEEDTD= see page 35 PRNOPA= see page 35 PRACT= see page 35
U-Alarm (<i>UALARM</i>)	407	1,2,3,4	Adjust unload alarm setting
Set over/Under (<i>SETOUT</i>)	426	SIGOV SIG12V	Select SIG12V for +12VDC output when over or under set point. See Page 37
Tolerance (<i>TOLER</i>)	442	WEIGHT PERCNT	Set a value for tolerance weight to compensate for truck overflow

SETTING [display]	D.A.N NO.	OPTIONS [display] BOLD=DEFAULT	DESCRIPTION
Preset Active Signal Timeout <i>{PRST}</i>	475	Enter XX:XX	Time to continue preset active signal after preset is reached. See page 36.
Unload Weight Displayed <i>{UNWED}</i>	476	NET GROSS LOAD	See page 36.
Auto Load Preset <i>{ALP}</i>	477	OFF , STORED, TRUCK, PARTCP	See page 37
MENU 5. CONTROL SETTINGS			
RPM Start /Stop <i>{RS5CTL}</i>	531	ON	ON enables automatic start/stop feature using RPM sensor on PTO shaft.
RPM Stop Speed <i>{RS5MIN}</i>	532	300	Set to 20%-50% of PTO operating RPMs. Stop is activated using this value.
RPM Start Tolerance <i>{RS5TOL}</i>	533	100	Set to 10% of PTO operating RPMs. Start is activated using this value added to DAN 532 (400)
RPM Start Delay <i>{RS5TD4}</i>	534	2	Time in seconds. Start is activated when RPMs are above DAN 532 + DAN 533 for this period.
RPM Stop Delay <i>{RS5PD4}</i>	535	2	Time in seconds. Stop is activated when RPMs are below DAN 532 for this period.
CALIBRATION			
Setup Number <i>{SETUP}</i>	871		Quick entry method selects weigh method 1-4lbs, 5-8kg, gain 1-9, display counts 1-9 and capacity *1000.

SETTING [display]	D.A.N NO.	OPTIONS [display] BOLD=DEFAULT	DESCRIPTION
Calibration Number (<i>CR</i> L)	872		Weight displayed at .4mV/V for these load cells.

Preset Active Signal Functionality

Detailed below are different 12 VDC outputs available with the GT460.

D.A.N. 406 Settings:

- OFF – No 12VDC output will be activated.
- SETPNT – Set Point
 - Uses the weight threshold to activate and deactivate the 12VDC output.
- PRESET – Standard preset relay, lamp, and alarm functionality.
 - Uses the preset to determine the pulses of the light, buzzer, and 12VDC output.
- SEEDTD – Seed Tender
 - During unloading the 12VDC output is activated and once the preset is reached the light, buzzer, and the signal deactivates. The light and buzzer also pulse when the pre-alarm is active.
- PRNOPA – Preset No Pre Alarm
 - Uses the preset and pre alarm for the light and buzzer, but the 12VDC output is only activated by the preset being reached.
- PRACT – Preset Active Signal
 - During unloading the 12VDC output is active before the preset weight is reached and the output deactivates when the preset is reached. The light and buzzer are linked to the pre-alarm and active until unloading is complete.

D.A.N. 426 Settings:

Sets the state of the 12VDC output when PRESET, SEEDTD, PRNOPA, or PRACT is selected in the D.A.N 406 menu. The SIG 12V setting will configure the indicator to activate the 12VDC output when a preset weight is reached. The normal state of the signal will be 0V. The SIG 0V setting will maintain a 12VDC output when the preset is not active and will switch to 0V when the preset is active. The default mode is SIG 12V.

D.A.N. 475 Settings:

Determines the behavior of the 12VDC output when D.A.N 406 is set to PRESET, SEEDTD, PRNOPA, or PRACT. When a time between 0.1 to 99.9 seconds is entered, and D.A.N 406 is set to PRESET the indicator will activate the 12VDC output when the preset is reached, delay for the specified time, and set the output to 0VDC after the delay period. When this is set to zero the 12VDC output will activate when the preset is reached and stay active until the preset is cleared. The preset is cleared when unloading stops. The default time is zero.

When unloading is stopped through the Start/Stop button or through AutoLog₂ the 12VDC output deactivates.

D.A.N. 442 Settings:

This setting allows the 12VDC output to activate before the preset is reached. It can be utilized in any D.A.N 406 mode, other than OFF. The TOLER setting allows the operator to tune in the preset signal based on the intended equipment. The TOLER can be set to WEIGHT or PERCNT. This setting creates a window, based around the preset weight, and will activate the 12VDC output, according to the selected D.A.N 406 configuration, when the measured weight is within that window.

D.A.N 476 Settings:

Used to change the normal view of the weight during the unloading process. There are three modes, NET, GROSS, and LOAD. Default mode is NET.

NET is the normal grain cart unloading method where the indicator counts down from zero and displays negative weight throughout the unloading.

GROSS allows the display of the actual or gross weight of the indicator and counts down from the total loaded weight.

LOAD displays the active preset weight and counts down from that value. If more than the prescribed preset is unloaded, the display will begin to count down from zero and show a negative number.

D.A.N 477 Settings:

Determines if the preset is loaded when unloading begins, default is OFF. Every unloading cycle will use the loaded preset. See page 14.

- OFF – No preset active.
- STORED – Enter an amount for the maximum truck capacity
 - Used every time no matter if different trucks with different capacities are used.
- TRUCK – Enter an amount for each truck
 - Used to enter a different preset amount depending on each trucks capacity.
- PARTCP – Enter any amount
 - Used if a less than full load is required.

To keep the 12VDC output signal deactivated during the unloading process when any D.A.N. 477 setting is ON, press  before starting PTO.

12VDC Output Diagrams

The diagrams on the following pages show the functionality of the 12VDC output when D.A.N 426 is set to SIG 12V. SIG 0V reverses the output.

PRESET Active Signal

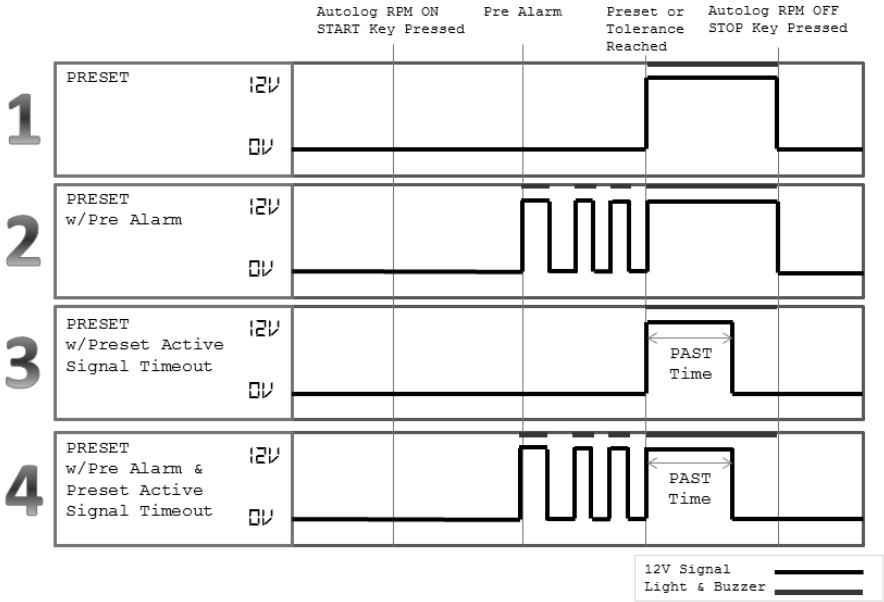

1) PMTHD RELAY SETOUT PAST	D.A.N. 401 D.A.N. 406 D.A.N. 426 D.A.N. 475	- P ALM = 0 - PRESET - SIG12V - 0.0	All modes require D.A.N. 477 to <u>not</u> be OFF.
2) PMTHD RELAY SETOUT PAST	D.A.N. 401 D.A.N. 406 D.A.N. 426 D.A.N. 475	- PERCNT OR WEIGHT-PALM>10 - PRESET - SIG12V - 0.0	
3) PMTHD RELAY SETOUT PAST	D.A.N. 401 D.A.N. 406 D.A.N. 426 D.A.N. 475	- P ALM = 0 - PRESET - SIG12V - 5.0	
4) PMTHD RELAY SETOUT PAST	D.A.N. 401 D.A.N. 406 D.A.N. 426 D.A.N. 475	- PERCNT OR WEIGHT-PALM>10 - PRESET - SIG12V - 5.0	

SEEDTD Active Signal

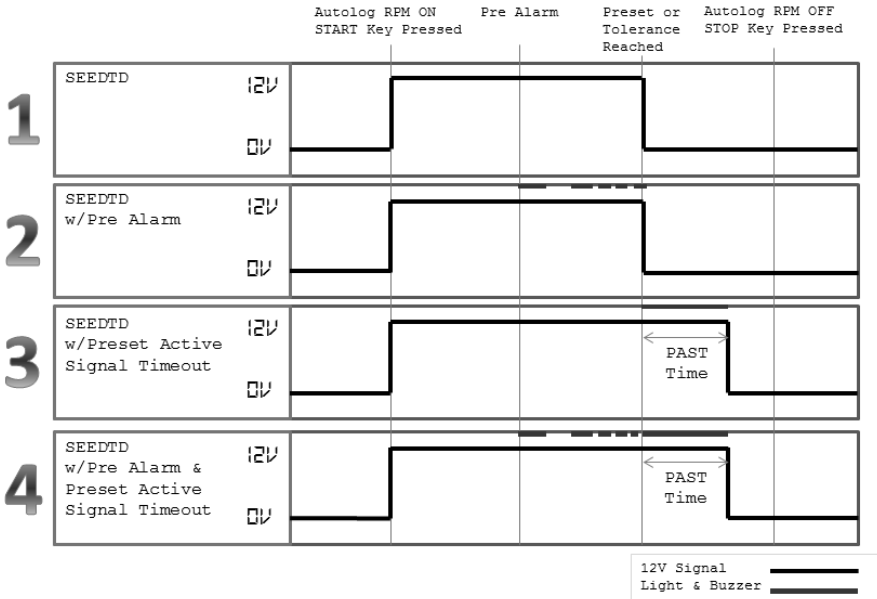

1) PMTHD RELAY SETOUT PAST	D.A.N. 401 D.A.N. 406 D.A.N. 426 D.A.N. 475	- P ALM = 0 - SEEDTD - SIG12V - 0.0	All modes require D.A.N. 477 to <u>not</u> be OFF.
2) PMTHD RELAY SETOUT PAST	D.A.N. 401 D.A.N. 406 D.A.N. 426 D.A.N. 475	- PERCNT OR WEIGHT-PALM>10 - SEEDTD - SIG12V - 0.0	
3) PMTHD RELAY SETOUT PAST	D.A.N. 401 D.A.N. 406 D.A.N. 426 D.A.N. 475	- P ALM = 0 - SEEDTD - SIG12V - 5.0	
4) PMTHD RELAY SETOUT PAST	D.A.N. 401 D.A.N. 406 D.A.N. 426 D.A.N. 475	- PERCNT OR WEIGHT-PALM>10 - SEEDTD - SIG12V - 5.0	

PRNOPA Active Signal

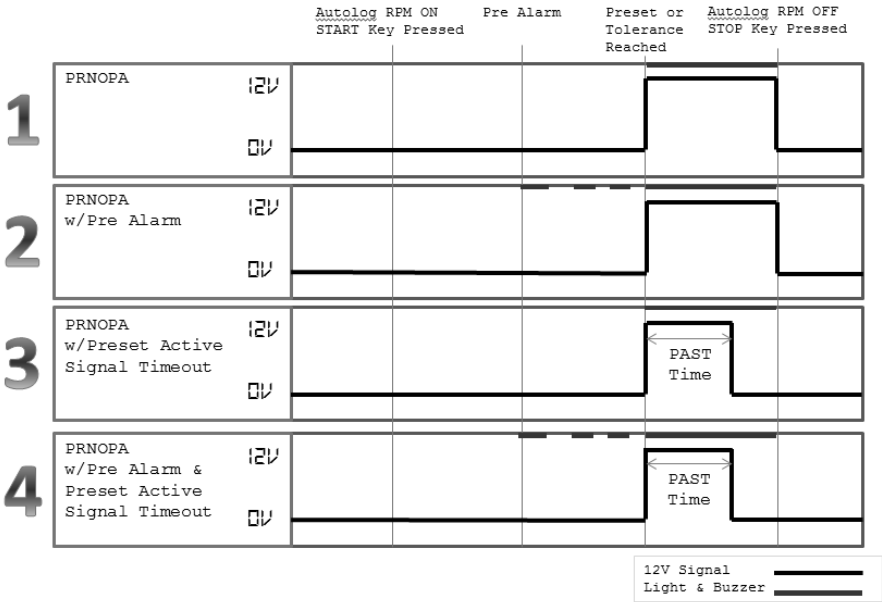

1) PMTHD RELAY SETOUT PAST	D.A.N. 401 D.A.N. 406 D.A.N. 426 D.A.N. 475	- P ALM = 0 - PRNOPA - SIG12V - 0.0	All modes require D.A.N. 477 to <u>not</u> be OFF.
2) PMTHD RELAY SETOUT PAST	D.A.N. 401 D.A.N. 406 D.A.N. 426 D.A.N. 475	- PERCNT OR WEIGHT-PALM>10 - PRNOPA - SIG12V - 0.0	
3) PMTHD RELAY SETOUT PAST	D.A.N. 401 D.A.N. 406 D.A.N. 426 D.A.N. 475	- P ALM = 0 - PRNOPA - SIG12V - 5.0	
4) PMTHD RELAY SETOUT PAST	D.A.N. 401 D.A.N. 406 D.A.N. 426 D.A.N. 475	- PERCNT OR WEIGHT-PALM>10 - PRNOPA - SIG12V - 5.0	

PREACT Active Signal

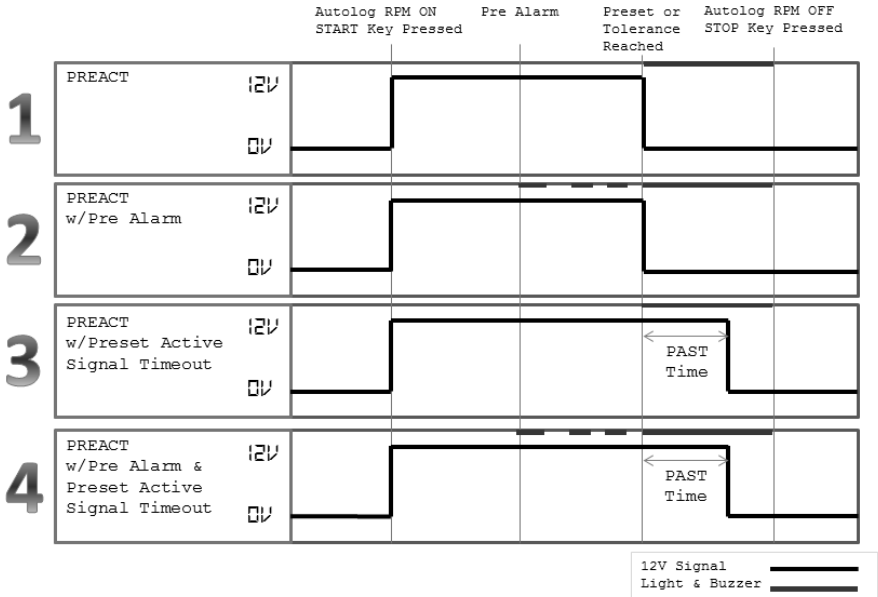

1) PMTHD RELAY SETOUT PAST	D.A.N. 401 D.A.N. 406 D.A.N. 426 D.A.N. 475	- P ALM = 0 - PREACT - SIG12V - 0.0	All modes require D.A.N. 477 to <u>not</u> be OFF.
2) PMTHD RELAY SETOUT PAST	D.A.N. 401 D.A.N. 406 D.A.N. 426 D.A.N. 475	- PERCNT OR WEIGHT-PALM>10 - PREACT - SIG12V - 0.0	
3) PMTHD RELAY SETOUT PAST	D.A.N. 401 D.A.N. 406 D.A.N. 426 D.A.N. 475	- P ALM = 0 - PREACT - SIG12V - 5.0	
4) PMTHD RELAY SETOUT PAST	D.A.N. 401 D.A.N. 406 D.A.N. 426 D.A.N. 475	- PERCNT OR WEIGHT-PALM>10 - PREACT - SIG12V - 5.0	

WEIGHING ERROR MESSAGES

OVRCAP

Capacity Limit:

Weight on scale system exceeds capacity limit.

+RANGE

Over Range:

Weight on scale system exceeds maximum weight.

-RANGE

Under Range:

Weight on scale system less than minimum weight.

INSTALLATION

INDICATOR MOUNTING

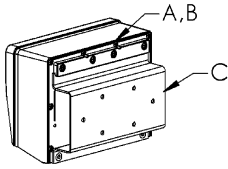

RAIL MOUNT

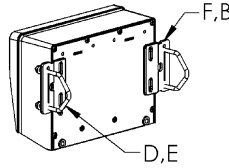

WING MOUNT

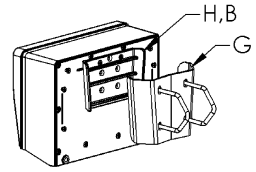

WEDGE MOUNT

KEY	PART NUMBER	DESCRIPTION
A	404353	BRACKET-EZ3 PLASTIC RAIL
B	403780	SCR-#10 X 5/8 FHSTS BLACK ZP
C	840459	SUPPORT-HAT BRACKET
D	405069	U-BOLT 1/4-20 X 3.25 ZP
E	405084	NUT-1/4-20 TOP LOCKING FLANGE
F	403770	BRACKET- WING MOUNT
G	405124	PACK-WEDGE MOUNT BRACKET WITH U-BOLTS & FLANGE NUTS
H	405244	EZ3 WEDGE MOUNT

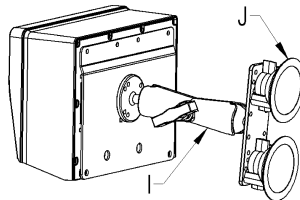

RAM MOUNT

KEY	PART NUMBER	DESCRIPTION
I	404799	RAM MOUNT FOR EZ III INDICATOR WITH HARDWARE
J	404230	RAM SUCTION CUP W/TWIST LOCK

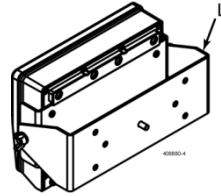
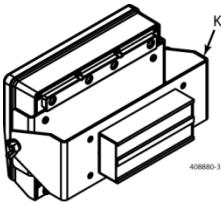

MAGNETIC SWIVEL MOUNT

KEY	PART NUMBER	DESCRIPTION
K	408880	MOUNT FOR EZ 3 INDICATOR WITH HARDWARE AND MAGNET
L	408828	MOUNT FOR EZ 3 INDICATOR WITH HARDWARE WITHOUT MAGNET

Cable Connection

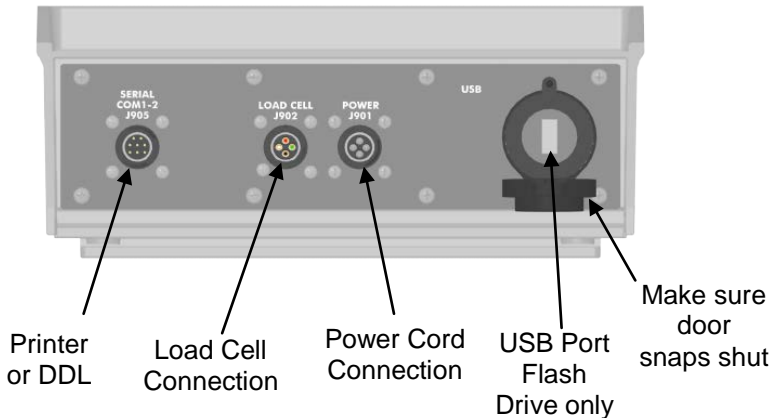

Pin	To 12VDC Power Supply	
1	Red	+Terminal
2	Black	-Terminal
3	Orange	Alarm Out
4	Blue	Remote Input

Bottom Panel Cable Connections

Connect Load Cells to J-Box

Connect load cell wires to terminal blocks. See Wire Color Key

J-Box Illustrated for 4 Load Cell Installation

Wire Color Key		
	Color	Description
1	White	Signal +
2	Green	Signal -
3	Red	Excitation +
4	Black	Excitation -
5	Shield	Shield

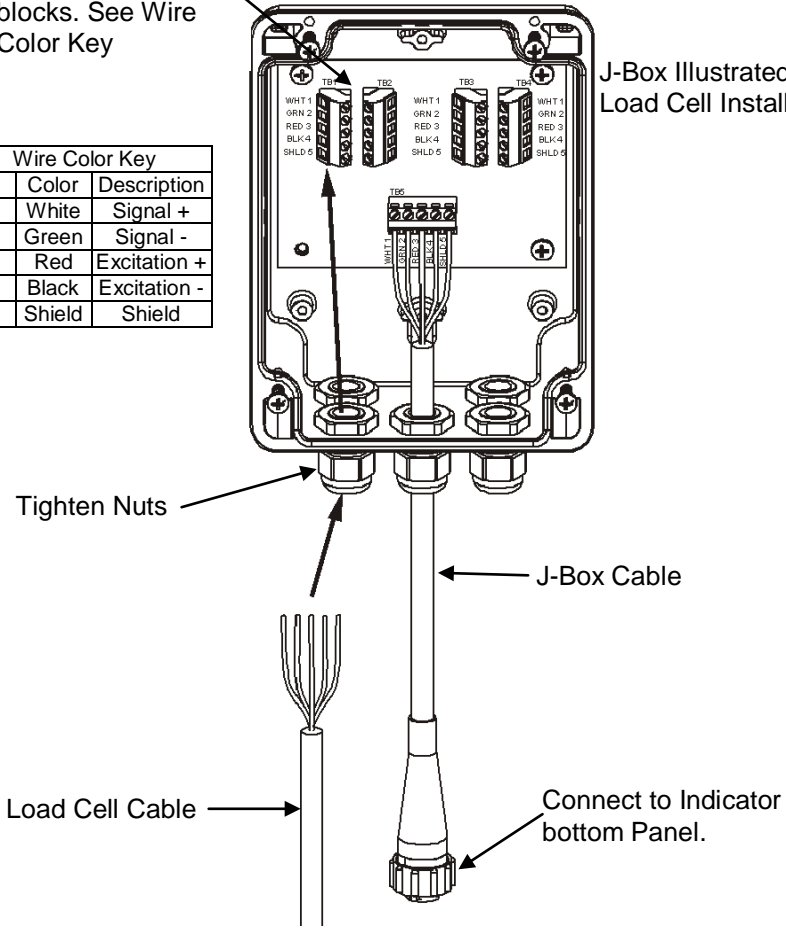

J-Box Connections

AUTOLOG₂ TROUBLESHOOTING

If your system has been operating, execute the following sensor diagnostics to verify the RPM sensor is sending pulses to the indicator.

RPM Sensor Diagnostics

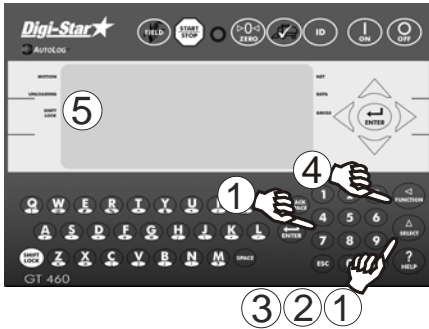

1. Enter 508 press **SELECT**
2. Press **SELECT** to select *DIY* and press enter.
3. Press **SELECT** until *DIAG* is displayed.
4. Press **FUNCTION**
5. Display will show value from RPM sensor.

Note:

The RPM value should be close to the actual RPMs of the shaft.

For best results adjust the distance between the sensor and the target to between 0.1" and 0.2" (2mm to 5mm). This is equal to the thickness of one to two quarters.

Sensor has yellow LED indicator on rear to indicate target in range of the sensor.

DIAG is to be used as a diagnostic tool. Repeat steps 1 and 2 to select *OFF* once troubleshooting is complete.

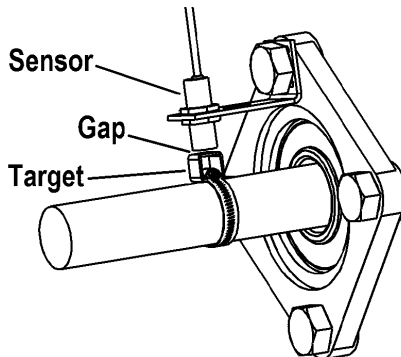





SENSOR AND TARGET INSTALLATION

Verify AutoLog₂ Settings

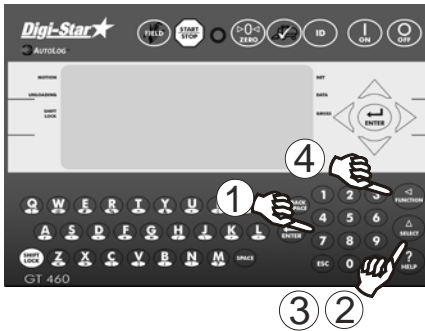
Verify that your AutoLog₂ setting located in Menu 5 are correct. These settings include D.A.N. numbers 531 thru 535. See page 34 for default settings. Your settings may vary.



Example: Turn RSCCTL to "ON"

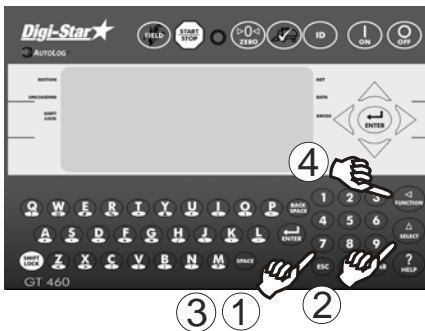

1. Enter 531
2. Press 
3. Press  to set RSCCTL to "ON"
4. Press  to save setting and return to the active screen.

Example: Turn RSSMIN to "300"



1. Enter 532
2. Press 
3. Enter 3, 0, 0 on keypad.
4. Press  to save setting and return to the active screen.

CHARGING BATTERY OR WELDING

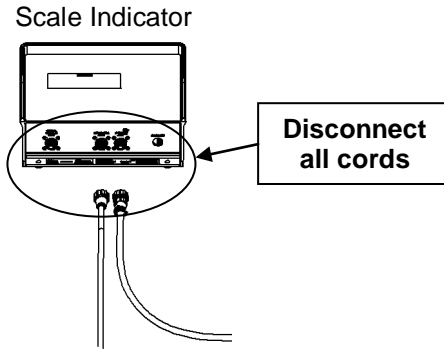

Important: Disconnect all indicator leads before charging battery or welding. Damage may occur to indicator and load cells.