



## GT560 AUTOLOG

### Operators Manual



Digi-Star LLC  
W5527 Hwy 106  
Fort Atkinson, WI 53538  
USA  
Tel: 800-225-7695  
E-mail: sales@digistar.com

Digi-Star International  
Digi-Star Europe B.V.  
J.F. Kennedylaan 235  
NL-5981 WZ Panningen  
The Netherlands  
Tel: +31 (0)77 462 92 64  
E-Mail: dsinfo@digistar.com

D4168-EN GT560 Autolog Rev A LAC

All rights reserved. Reproduction of any part of this manual in any form whatsoever without Digi-Star's express written permission is forbidden. The contents of this manual are subject to change without notice. All efforts have been made to assure the accuracy of the contents of this manual. However, should any errors be detected, Digi-Star would greatly appreciate being informed of them. The above notwithstanding, Digi-Star can assume no responsibility for errors in this manual or their consequence.

© Copyright 2016 Digi-Star Fort Atkinson (U.S.A.)

## Table of Contents

GETTING STARTED .....	5
1.0 INTRODUCTION .....	6
2.0 GT560 FEATURES & OPTIONS.....	7
3.0 ACCURACY STATEMENT .....	9
4.0 TECHNICAL SPECIFICATIONS .....	10
5.0 SAFETY DURING USE.....	11
6.0 HARVEST TRACKER MANAGEMENT PC SOFTWARE .....	12
7.0 HARVEST TRACKER APP .....	13
8.0 GT560 INDICATOR OVERVIEW .....	14
9.0 INDICATOR DISPLAY SCREENS .....	17
9.1 Overview of Active Screen .....	18
9.2 Overview of Data Record Screen .....	19
9.3 Overview of Field Screen .....	20
9.4 Overview of ID Screen.....	21
9.5 Overview of GPS Screen.....	22
9.6 Overview of Grain Moisture Screen.....	23
10.0 OVERVIEW OF THE LOAD SCREEN, MOISTURE AND GPS DATA. ....	24
11.0 CALIBRATING GRAIN MOISTURE SETTINGS.....	25
12.0 OVERVIEW FOR DATA TRANSFER.....	26
12.1 Transfer Field and ID data from USB to GT560 indicator.....	26
12.2 Transfer Records from GT560 indicator to USB Drive .....	26
13.0 OPERATION.....	27
13.1 Record Data – Automatic Mode (With AutoLog) .....	27
13.2 Record Data - Manual Mode (without AutoLog or AutoLog <sub>2</sub> ) .....	28
13.3 Record Data Preview.....	28
13.4 GPS Coordinates Preview for Record Displayed .....	29
13.5 Moisture Information Preview for Record Displayed .....	29
13.6 Check Combine Yield Monitor .....	30
14.0 AUTOLOG <sub>2</sub> .....	31
14.1 To Enable Autolog <sub>2</sub> And Options .....	31
14.2 Enable Relay Function .....	32
14.3 Time To Continue Preset Active Signal .....	32
14.4 Select Weight Or Percentage Method .....	33
15.0 RE-CALIBRATING THE SCALE .....	34
15.1 View Current Calibration Number .....	34
15.2 Enter New Calibration Number .....	35

15.3 Changing/Viewing Setup Number.....	35
16.0 DAILY DATA COLLECTION .....	36
16.1 To Store Data Records On A USB Drive .....	36
16.2 Erase Data Records From GT560 Indicator.....	37
16.3 Zero Accumulator Memory .....	37
17.0 Other Functions .....	38
17.1 Backlight Dimmer .....	38
17.2 Unload Alarm .....	38
17.3 Change Time.....	39
17.4 Change Date .....	39
17.5 Edit Sign On Message.....	40
18.0 DIRECT ACCESS NUMBERS (D.A.N.) .....	41
18.1 Options Changed By User.....	41
19.0 PRESET ACTIVE SIGNAL FUNCTIONALITY.....	53
20.0 12VDC OUTPUT DIAGRAMS.....	55
20.1 PRESET Active Signal Diagram .....	55
20.2 SEEDTD Active Signal Diagram .....	56
20.3 PRNOPA Active Signal Diagram .....	57
20.4 PRACT Active Signal Diagram .....	58
21.0 WEIGHING ERROR MESSAGES.....	59
21.1 OVRCAP .....	59
21.2 +RANGE .....	59
21.3 -RANGE .....	59
22.0 TROUBLESHOOTING FLOW CHART.....	60
22.1 Troubleshooting Flow Chart Continued .....	61
23.0 INSTALLATION .....	62
23.1 Indicator Mounting.....	62
24.0 CABLE CONNECTIONS.....	65
24.1 Indicator Connection Diagram .....	66
24.2 Connecting Load Cells To Junction Box .....	67
24.3 Load Cell Direction .....	67
25.0 AUTOLOG TROUBLESHOOTING.....	68
26.0 SENSOR INSTALLATION AS PROXIMITY SWITCH .....	69
27.0 DECLARATION OF CONFORMITY.....	70
28.0 NOTES .....	71
29.0 QUICK REFERENCE AID.....	72
30.0 OPTIONS.....	73

## GETTING STARTED

**Before Harvest**



1. Install Harvest Tracker Software on PC and enter required data. See Page 12.
2. Install optional AutoLog Sensor on PTO shaft. See Page 31.
3. Install optional Grain Moisture Sensor on discharger chute of equipment and calibrate. See Page 25.
4. Install optional GPS Sensor on equipment.
5. Transfer data for Harvest Tracker software to GT560 Indicator.

**Before Loading**

1. Select Field (See page 20)
  2. Select ID (See page 21)
  3. Select Grain (See page 23)
- Refer to Section 13-Operation Page 27.

**Before Unloading**

If AutoLog is not used

1. Press . UNLOAD should be flashing.
2. When done unloading press . The display will stay on for 10 seconds then return to active screen and is ready to load.

## 1.0 INTRODUCTION

Thank you for the purchase of a GT560 system. Your GT560 is the culmination of more than 30 years of agricultural weighing engineering and expertise. With proper operation and preventative maintenance it will last for many years.

The Digi-Star GT560 is designed for use with weighing, tracking, storing, and transferring related data regarding the weight of agricultural grains, forages, and other commodities on mobile weigh wagons, grain carts, forage boxes, and other agricultural conveyances.

The data collected by, and transferred from, the GT560 is designed primarily for use with Digi-Star's Harvest Tracker PC software. For maximum value from the GT560 indicator, Digi-Star recommends that Harvest Tracker PC software program be loaded on a computer. This program will allow the full initialization and personalization of the GT560 indicator to the operation. The manual for this software program is found within the program under the help tab.

The GT560 is not for use with applications for which the GT560 is not intended, or as outlined in this manual.

Use of the GT560 outside of its intended purposes may result in inaccurate weight measurement or damage to indicator.

Wi-Fi and Harvest Tracker App can be used with the GT560 indicator.

### Reference Documents:

D4172-EN Grain Moisture Sensor Installation

D3908-EN AutoLog Installation Manual

Digi-Star website: [www.digi-star.com](http://www.digi-star.com)

Technical Support: Toll Free 800-225-7695 (US & Canada); +1-920-563-9700

## 2.0 GT560 FEATURES & OPTIONS

### The GT 560 Indicator offers several unique features:

- Grain Moisture Data recording during unloading and Dry Bushel calculation (Option)
- GPS Location Data recorded for both Loading and Unloading locations (Option)
- Bright, clear, white backlit COG display that is easier to read
- Increased microprocessor power with firmware updatable via USB stick
- Hour Meter, Maintenance Message, and Custom Sign-On Message

### Hands off (AutoLog) Operation

The GT560 indicator has many features but it also boasts simple hands-off operation using a RPM sensor on the PTO shaft to trigger the start of the unloading process and the end of the unloading process. AutoLog aids in preventing operator mistakes and loss of load data due to the operator forgetting to push the “start/stop” key. Manual control using the “start/stop” key is possible should the sensor be damaged or not functioning by disabling AutoLog. See page 31 for instructions. Weight, date, time and additional information are stored automatically after each load is completed.

### AutoLog<sub>2</sub>

AutoLog<sub>2</sub> is an optional function which allows the operator to set weight targets when unloading. The indicator will sound an alarm and/or activate a control signal when the preset unload weight is met.

There are 3 methods available to control the targeted unloaded weight:

1. **Weight set per Truck ID** – Each truck with a stored ID can have a preset weight. This feature is useful when working with trucks of various capacities.
2. **Stored Target Weight**- When the same amount is unloaded each time. The stored weight repeats until changed. Useful when all trucks have the same capacity.
3. **Load by Load**- With each unloading event the GT560 will prompt the operator to enter the required weight to unload. Useful when flexibility is required.

### USB Port

USB drive has capacity to hold thousands of data records and allows easy data transfer.

### Harvest Tracker PC Software

Harvest Tracker PC software provided with GT560 indicator allows generation of a variety of reports. Reports can be read by programs such as Microsoft Excel, Adobe Acrobat and Microsoft Internet Explorer.

### Wi-Fi ERM

The Digi-Star ERM-WIFI device allows Apple and Android devices to wirelessly communicate with Digi-Star GT560 indicator.

### GPS

A GPS receiver will also record the “where the load started GPS coordinates, the Field, the Crop” and the “where the unloading stopped GPS Coordinates, the unloaded weight, the Field, the Crop, the Moisture”.

**Grain Moisture Sensor**

A grain moisture sensor mounted in the unloading system of the grain cart will monitor and record the average moisture of the grain when being unloaded. Grain must be moving over or across the Grain Moisture Sensor.

**Harvest Tracker App**

Easily view and control the GT560 scale indicator remotely from Android and IOS phones or tablets. View weights, initiate check combine function, and edit field names from the combine.



### 3.0 ACCURACY STATEMENT

**ACCURACY:****READ THIS SECTION BEFORE USING THE SCALE SYSTEM**

Digi-star scale systems are manufactured to provide the greatest accuracy possible. To obtain the highest level of accuracy proper design, installation and use are required.

When using the scale system the following must be considered in order to realize the best possible performance and accuracy:

- Load cells must be installed with the proper orientation. Most Digi-Star load cells have a label indicating either the “top” or bending direction of the load cell. Inspect load cells to determine if installation is correct. Installation of any load cells with the orientation incorrect will result in inaccurate measurement.
- Load cell should not be subjected to any strains or loads other than the weight of the load. Stress or strain caused by misalignment or other factors when accurate weight readings are desired will negatively affect the accuracy.
- The weighing unit should be stationary, with minimal movement, and on level surface to insure that weight readings are as accurate as possible.
- The effect of movement on accuracy depends on the speed and roughness of the ground and application. Rougher terrain and faster and/or greater movement increase the degradation of accuracy.
- A level surface is defined as being less than a 5” (13cm) of run. As the slope of the terrain increases, degradation of accuracy will also increase.

**4.0 TECHNICAL SPECIFICATIONS**

SIZE	10.25" long x 8.0" high x 4" wide (260mm x 190mm x 105mm)
WEIGHT	4.5 lbs. (2.04 Kg)
HELP MESSAGES	Context sensitive help messages in 10 languages, Long messages are scrolled
LOAD CELL EXCITATION	8 volts D.C. Nominal, Capable of driving ten 350 Ohms transducers, Short circuit proof
AUTO TEMP COMPENSATION	Of internal circuitry for high accuracy weighing measurements
LOAD CELL SIGNAL	Compatible with Load Cells with greater than 0.25 mv/v
CONNECTORS	AMP plastic weather resistant circular connector. Gold plated contacts.
POWER REQUIREMENTS	10.5 to 16.0 VDC 160 mA nominal with four 350Ω L.C.
SETUP & CALIBRATION	Via front panel or saved when downloading the setting files.
GROSS RANGE	999,999 max-display
LOW BATTERY WARNING	Enabled at 10.5V nominal
POUND/KILO	Selectable
DISPLAY	LCD with 84 Character Display.
DISPLAY RESOLUTION	.01, .02, .05, .1, .2, .5, 1, 2, 5, 10, 20, 50, 100
DISPLAY UPDATE RATE	Selectable: 1, 2, 3, 4 times/sec.
MAX. DISPLAY RESOLUTION	Adjustable to 40,000 counts max.
ZERO TRACKING	Selectable, On/Off
SPAN ACCURACY	±(.1% + .005%/ °F) or (.1% + 0.009% °C) full scale ± 1 output count
MOTION DETECTION	Selectable, On/Off
ZERO ACCURACY	(.005%/ °F) or (0.009% °C) full scale ±1 output count for 0.5 mv/v transducer
ENVIRONMENTAL ENCLOSURE	IP65, IEC 529
WEIGH ALGORITHM	3 internally selectable digital filters to optimize performance (General, Slow, and Fast)
NON-VOLATILE MEMORY	Standard
OPERATING TEMP	-29°C to 60°C -20°F to 140°F
2 REMOTE INPUTS (power/ remote ports)	Tare / Print / Hold / Net Gross / M+ / Zero / TR Hold / Re-enter Preset / Switch

## 5.0 SAFETY DURING USE

 **Danger:** Indicates an imminently hazardous situation that, if not avoided, could result in death or very serious injury.

 **Warning:** Indicates a potential hazardous situation that, if not avoided, may result in death or very serious injury.

 **Caution:** Indicates a potential hazardous situation that, if not avoided, may result in a minor injury.

### IMPORTANT

**USB Port Function**—The USB port is only to be used to upload or download data from a USB Memory Stick. The USB Port is not to be used as a charging port for any type of electronic device. Use of the USB Port for any purpose other than for which it is designed may void the product's warranty.

**Cleaning:** Do not use running water, pressure washer or hoses to clean the indicator or touch screen.

**Charging Battery:** Disconnect all cables from the indicator and touch screen before charging the battery or welding on the machine. If cables are left connected, the indicator, touch screen and connected load cells could be damaged.

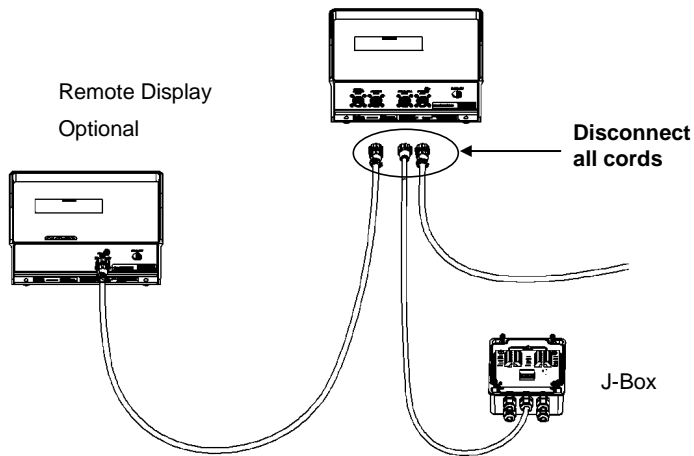

## 6.0 HARVEST TRACKER MANAGEMENT PC SOFTWARE

- Adding or Modifying Field Names and ID Names
- Using Harvest Tracker PC software:
- Upload data records from USB drive to PC.
- Delete field names that are already finished and clear their accumulators.
- Add/Modify new field names and ID names as needed.
- Transfer the new field names, accumulators and ID names onto the USB drive.

**Note:** To upload data to indicator, you must first create data files with field names, ID names and accumulator values using Harvest Tracker PC software.

## 7.0 HARVEST TRACKER APP

Easily view and control the GT560 scale indicator remotely from Android and IOS phones or tablets. View weights, initiate check combine function, and edit field names from the combine.

### Harvest Tracker App Features:







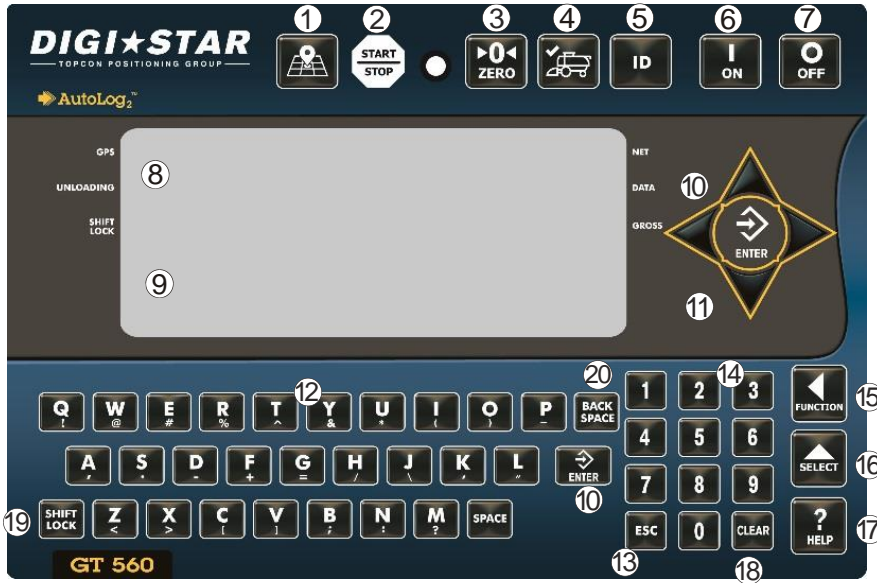

- Field—View and edit field names
- ID—View and edit destination IDs
- SYNC—Sync records from to online Harvest Tracker or PC Harvest Tracker
- Check Combine—Check combine yield monitor
- Zero—Press and hold to zero balance the scale
- Start/Stop—Start or stop unloading operation









Digi-Star website: [www.digi-star.com](http://www.digi-star.com)

## 8.0 GT560 INDICATOR OVERVIEW



- ①  Enter and exit Field screen.
- ②  Start or stop unloading operation.
- ③  Press and hold to zero balance the scale.
- ④  Check combine yield monitor.
- ⑤  Enter and exit ID screen.
- ⑥  Turn indicator on.
- ⑦  Turn indicator off.
- ⑧ "Upper Display Window"—Displays recorded data-26 characters x3 rows.
- ⑨ "Lower Display"—Displays recorded data-26 characters x3 rows.
- ⑩  Accept change or recorded to next item.



- ⑪ Direction Arrows-Left or right arrows move cursor inside data field. Up and down arrows move to previous or next data field. List scrolls faster the longer the Up/Down arrow is held down.
- ⑫ “Qwerty Keyboard”
- ⑬  Escape or undo last data change.
- ⑭ Numbers Keypad
- ⑮  Performs task displayed by select
- ⑯  Scroll thru function key operation
- ⑰  For additional information
- ⑱  Delete one character in data entry field. Press and hold to delete entire data entry field contents.
- ⑲  Press and release. Then press key with desired special character.
- ⑳  Press to backspace. Press and hold to backspace faster.

**BOTTOM PANEL CONNECTIONS**

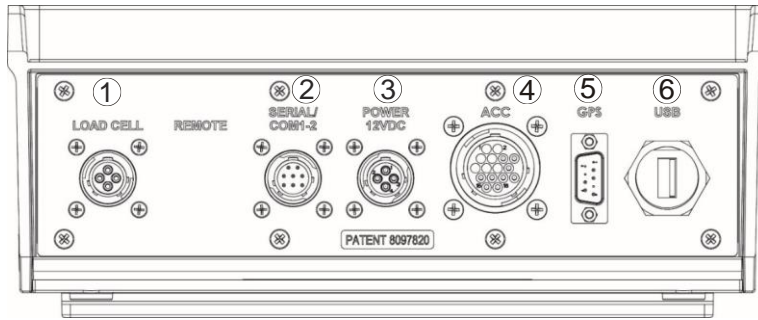

- ① Load cell port-- connection from J-Box
- ② Serial/com1-2 port--Computer connection
- ③ Power port--12VDC only
- ④ ACC port--
- ⑤ GPS port--
- ⑥ USB port—used for data transfer



## 9.0 INDICATOR DISPLAY SCREENS

Six display screens can be shown on the indicator:

### **Active Screen**

This screen includes ID, Time, Gross Weight, Print Accumulator and Field Name. See page 18.

### **Data Record Screen**

This screen includes Field Name, Net Weight, Print Accumulator, ID, GPS, Moisture, Date and Time. See page 19.

### **Field Screen**

150 field names are available and can be modified using the keypad. See page 20.

### **ID Screen**

150 ID names are available and can be modified using the keypad. See page 21.

### **GPS Screen**

GPS coordinates shows were the load was started and finished unloading. See page 22.

### **Moisture Screen**

This screen shows the average moisture content of material being unloaded. See page 23.

9.1 Overview of Active Screen



- ① Current weight.
- ② Current ID name
- ③ Current gross weight.
- ④ Current field name.
- ⑤ Time (5:23 PM shown).
- ⑥ Print accumulator (PA) for current field.
- ⑦ Moisture percentage when grain is flowing.
- ⑧ Current grain

**9.2 Overview of Data Record Screen**

The GT560 indicator creates “data records” that contain data from the fields each time the operator completes a load.

- Press **ESC** to view last stored record.
- Press **▲** and **▼** arrows to scroll through all previously stored records.
- Press **◀** arrow to view GPS coordinates.
- Press **▶** arrow to view weight, grain and moisture percentage.



- ① Load Number.
- ② Field name (26 characters).
- ③ Net Weight (weight that was unloaded for this load).
- ④ ID name (6 characters) (use for “CART ID” or “TRUCK ID”).
- ⑤ Date
- ⑥ Time
- ⑦ Print Accumulator (total of all loads for selected field).

**9.3 Overview of Field Screen**

- Field names can be uploaded from a PC using a USB drive with Harvest Tracker PC Software.
- Field names can be a maximum of 26 characters long.
- Field names can be added or edited using the keypads before unloading.

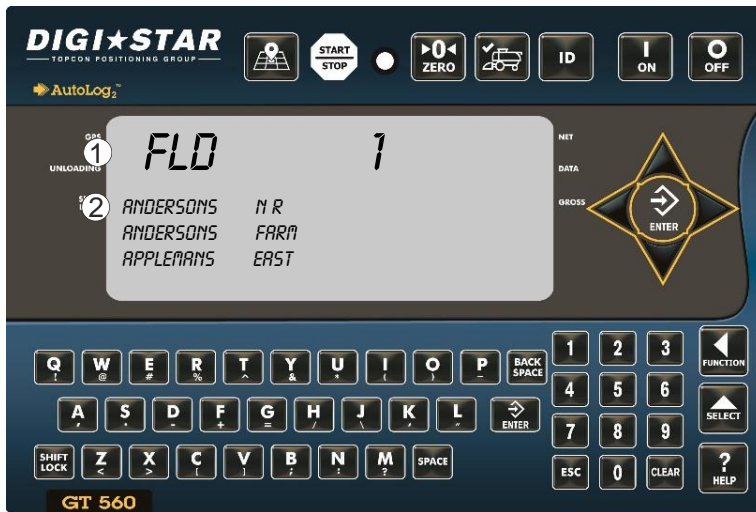

- ① Current field
- ② Current field name

1. Press to modify or select field. Current field number is shown in first line of the display.
2. Three lines are displayed in lower display window. The top line of the three is current, editable and will be used for next data record.
3. Press or arrows to scroll through fields (150 maximum fields). Continue holding the arrow to scroll faster. Use or arrows to move cursor within data line.
4. Use keypad to enter or update field names. Press to delete characters to left and press to delete the selected character. Hold for 2-3 seconds to delete entire line. Pressing will reset line to last saved data.
5. To use special characters, press and release . Then press key with desired special character. Repeat for each special character required.
6. Press or to exit.

**9.4 Overview of ID Screen**

- Auto load preset (ALP—D.A.N. 6302) must be enabled (ON).
- ID names can be uploaded from a PC using a USB drive with Harvest Tracker PC Software.
- ID names and capacities can be a maximum of 6 characters long.
- ID names can be changed by using the keypad before unloading.
- ID screen has two columns with ID on left and capacity on right of 3 line display.

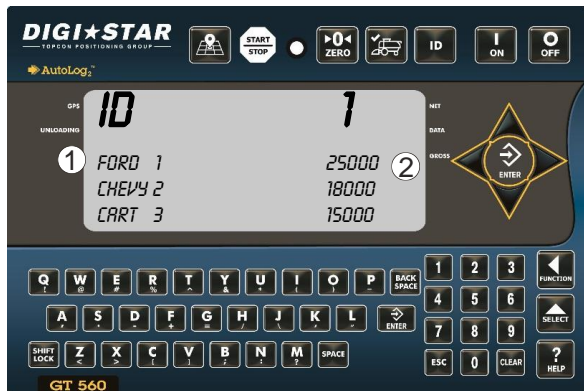

- ① Truck or grain cart identification
- ② Maximum load capacity of truck or cart

1. Press **ID** to modify or select ID name. Current ID number is shown in upper display.
2. Three lines are displayed in lower display window. The top line of the three is current, editable and will be used for the next data record.
3. Press **▲** or **▼** arrows to scroll through fields (150 maximum). Continue holding the arrow to scroll faster. Use **◀** or **▶** arrows to move cursor within data line.
4. Use keypad to enter or update ID names. Press **BACK SPACE** to delete characters to left and **CLEAR** to delete the selected character. Hold **CLEAR** to delete entire line. Pressing **ESC** will reset line to last saved name.
5. To use special characters press and release **SHIFT LOCK**. Then press key with desired special character. Repeat for each special character required.
6. The operator will see ID XXX while editing the ID and CAP XXX while editing the capacity. After editing the ID, press **ENTER** to move the cursor to capacity field to enter capacity data. The display will scroll to the next ID when pressing **▲** or **▼** arrows.
7. Press **ENTER** or **ID** to exit.

9.5 Overview of GPS Screen



- ① Current gross weight
- ② Current latitude
- ③ Current longitude
- ④ Direction & Current miles per hour
- ⑤ GPS Fixed Quality of Signal
- ⑥ Coordinated Universal Time
- ⑦ Number of satellites

1. Press  repeatedly until GPS is displayed.

2. Press .

3. Press  to return to main display.



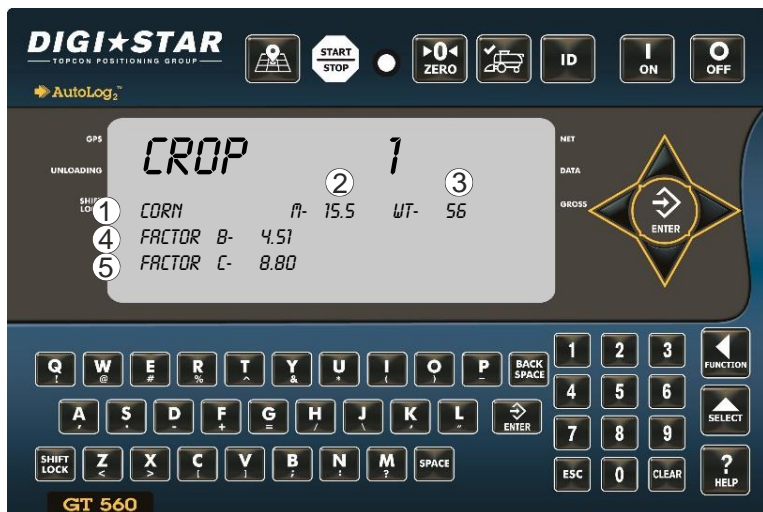

Note: This display shows current GPS coordinates, current weight, MPH, Satellite number and number of satellites found.

After 10 seconds the display will return to the Active Screen.

9.6 Overview of Grain Moisture Screen



- ① Current grain
- ② Moisture percentage
- ③ Weight per bushel
- ④ No user significance
- ⑤ See information below

1. Press  repeatedly until GRAIN is displayed.
2. Press .
3. To edit the FACTOR C, press  repeatedly until FACTOR C number is flashing.
4. Enter new number using keypad.
5. Press  to store.

Note: For more instructions when editing FACTOR C, see page 25.

**10.0 OVERVIEW OF THE LOAD SCREEN, MOISTURE AND GPS DATA.**



1. Press **ESC** to go to load screen.
2. Use **▲** and **▼** arrows to scroll through the different loads

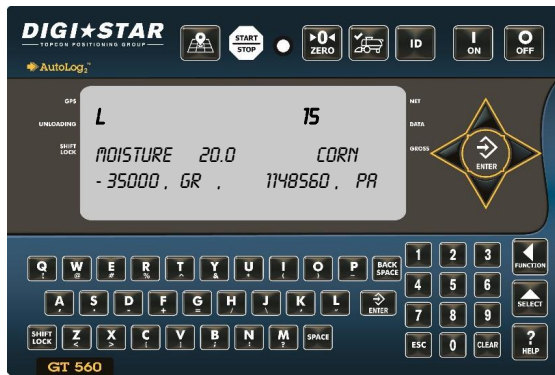

3. When the load is chosen to view, press **▶** arrow. Use arrows to view moisture percentage, grain and weight data

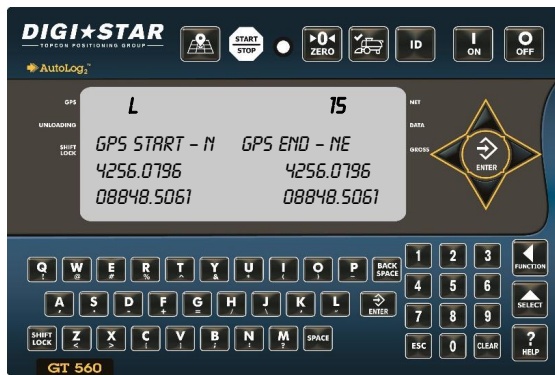

4. Press **◀** arrow twice to view GPS coordinates data from load being viewed.



## 11.0 CALIBRATING GRAIN MOISTURE SETTINGS

The GT560 indicator can be calibrated to the reference moisture (example; Hand Held, Elevator, Combine) the customer chooses to compare too. Grain must be moving continually over the grain moisture sensor during unloading to achieve accurate average moisture data. Placing the grain moisture sensor in the grain cart where the most grain flow is during unloading is recommended.

Example: After unloading corn from grain cart, moisture reading on the GT560 reads: 26.5%. Take a sample from the unloaded corn and check the moisture using the customer's choice of reference grain moisture system (example; Hand Held, Elevator, Combine) to compare the GT560 reading. Reference is 25.5%. This is a difference of 1%. Calibrate the GT560 moisture reading by adjusting FACTOR C following the steps below.

### Examples of moisture changes:

Moisture reading shown on the GT560: 26.5%.

Moisture reading from reference moisture: 25.5%.

Current Factor C is: 11.00.

Adjust Factor C too: 10.00, unload 2 or more loads from grain cart to verify moisture reading on GT560 with reference moisture used.

Moisture reading shown on the GT560: 20.0%.





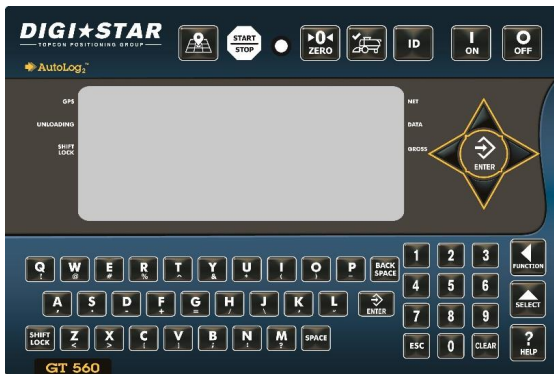

Moisture reading from reference moisture: 21.5%.

Current Factor C is: 10.00

Adjust Factor C too: 11.50, unload 2 or more loads from grain cart to verify moisture reading on GT560 with reference moisture used.



**Note:** See Grain Moisture Sensor Installation document D4172-EN for more detailed information.

1. Press  repeatedly until the text GRAIN is displayed, then release key.
2. Press .
3. Press  and  arrows to scroll through CROP names. Press  once when desired crop name is listed.
4. (Example; CORN, WHEAT, SOY, RICE etc.)
5. Then press  twice until FACTOR C number is flashing.
6. Using number keypad enter new number.
7. Press  to store.

## 12.0 OVERVIEW FOR DATA TRANSFER

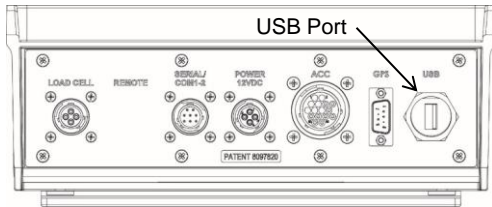

The GT560 indicator is equipped with a USB drive port. The USB drive used with the indicator holds thousands of data records and allows for easy transfer to PC.

### 12.1 Transfer Field and ID data from USB to GT560 indicator



1. Insert USB drive. Indicator will automatically detect the USB drive. USB IN will be display.
2. Using the number keypad, press 9 to transfer Field names and ID names from USB drive to GT560 indicator.
3. When data transfer is complete, the LCD display will return to the Data Transfer menu.

**Important:** This action will overwrite Field names, ID names and Accumulator on the GT560 indicator.

### 12.2 Transfer Records from GT560 indicator to USB Drive

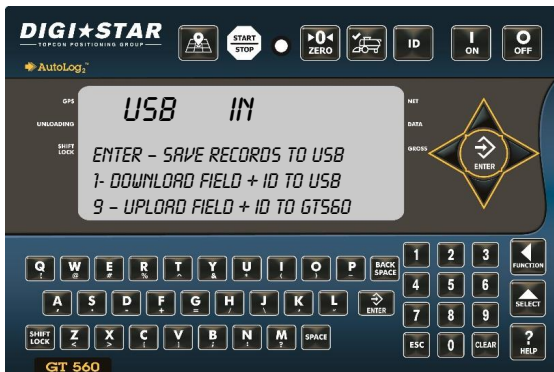



1. Insert USB drive. GT560 will automatically detect the USB drive. USB IN will be display.
2. Press  to save records from GT560 to USB drive.
3. Using number keypad, press 1 to transfer Field Names and ID names from GT560 to USB.
4. When data transfer is complete, the LCD display will return to the data transfer menu.

**Note:** This action appends values already on the USB drive. (Other saved data on the USB drive will not be over written.)

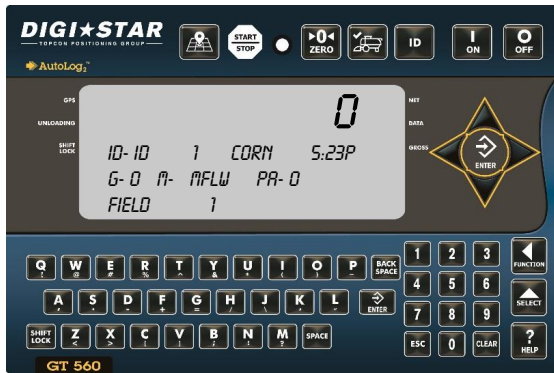
### 13.0 OPERATION









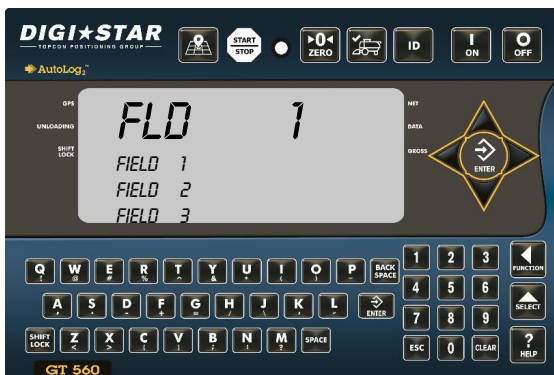

1. Press 
2. Press and hold  for 2 seconds to zero balance the GT560 indicator if the container is empty. Active screen is displayed.

#### 13.1 Record Data – Automatic Mode (With AutoLog)

**Note:** To operate GT560 with AutoLog the GT560 must be connected to a PTO speed shaft or switch sensor. In addition, the GT560 AutoLog functionality must be turned on. Check that D.A.N. 6401 is set to RPM for PTO or SWITCH for door opening. Also see installation manual **D3908** for rotation sensor installation.



1. Press 
2. Press  and  to select required field name.
3. Press 
4. Press  to select required ID.
5. Press  and  to select required ID name.
6. Press .

Note: Make sure the GT560 indicator has returned to active screen

**Note:** If AutoLog is not working correctly, see page 31 for set-up instructions.

**Note:** For information on how to use/ install the Sensor Installation as Proximity Switch on a grain or Forage container, see page 69.

7. If AutoLog is enabled, simply start the PTO. The GT560 will read zero and enter the net mode.
8. Unload grain from cart. The upper display shows the amount unloaded. Gross value (total amount left on Cart) is displayed on second line of the lower display.
9. If AutoLog is enabled, simply stop the PTO. Data record will be stored and displayed.

### 13.2 Record Data - Manual Mode (without AutoLog or AutoLog2)

**Note:** If the equipment is not fitted with a PTO shaft speed sensor or a FSWITCH sensor, the GT560 indicator must be operated in manual mode.



When the unloading process is complete:

- The data record is stored in memory of indicator.
- The data record screen will display the last data record for 10 seconds. Then the GT560 indicator will return to active screen.

### 13.3 Record Data Preview



1. Press to select required field name.

2. Press to select required ID.

**Note:** Make sure the GT560 has returned to the active screen.

3. Press before unloading grain from container. The GT560 indicator will read zero and enter the net mode.

4. Unload grain from grain container. The upper display shows the amount unloaded. Gross value (total amount left on container) is displayed on second line of lower display.

5. Press once the unloading process is complete.

1. Press to see last data record.

2. Press or arrows to scroll/view Data Records.

**Note:** After 10 seconds of no key pad activity, the GT560 indicator will return to the active screen.

**13.4 GPS Coordinates Preview for Record Displayed**





3. Press  arrow to view GPS coordinates for selected record.

**Note:** After 10 seconds of no key pad activity, the GT560 indicator will return to the active screen.

**13.5 Moisture Information Preview for Record Displayed**



4. Press  arrow to view Moisture value for selected record.
5. Press  to immediately return to the active

**Note:** After 10 seconds of no key pad activity, the GT560 indicator will return to the active screen.



6. Press  arrow to view Moisture value for selected record.
7. Press  to immediately return to the active screen.

**Note:** After 10 seconds of no key pad activity, the GT560 indicator will return to the active screen.



### 13.6 Check Combine Yield Monitor

For best accuracy, park on a level surface when pressing

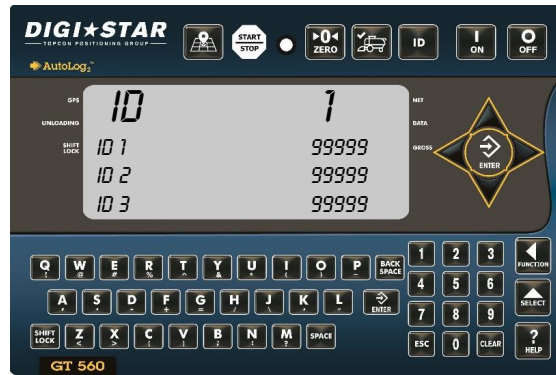

1. Press 
2. Bottom line displays WEIGH COMBINE GRAIN.



3. Press  name.
4. Press  and unload grain into container. Press  again when unloading is complete to save data to GT560.

## 14.0 AUTOLOG<sub>2</sub>

AutoLog<sub>2</sub> functionality is designed to provide assistance controlling the amount of grain unloaded from the grain cart or container. The operator can set weight targets to unload. The GT560 indicator will sound an alarm and/or activate a control signal to operate a switch or solenoid when the preset unload weight is met.

There are 3 methods available to control the targeted unloaded weight.

1. **Weight set per truck ID** – Each truck with a stored ID can have a preset weight. Useful when working with trucks of various capacities.
2. **Stored target weight** – When the same amount is unloaded each time. The stored weight repeats until changed. Useful when all trucks have the same capacity.
3. **Load by Load** - With each unloading event the GT560 will prompt the operator to enter the required weight to unload. Useful when flexibility is required.

Once set, preset control is activated by the AutoLog<sub>2</sub> functionality or by the  button.





In addition AutoLog<sub>2</sub> provides additional functionality by allowing maximum capacities of individual trucks to be stored on the GT560 indicator as part of the ID functionality.

See page 32 for additional details for using the Preset Active Signal Functionality connected with setting the preset weight option below.

### 14.1 To Enable Autolog<sub>2</sub> And Options





(Enable--90019)

1. Enter 6302, then press .
2. Press  again to change ALP setting other than .
3. Press  to store.

This setting allows preset weight values to be entered with the keypad, so that GT560 can control other functions based on a target weight. Turn this setting OFF for normal grain cart mode.

### 14.2 Enable Relay Function



1. Enter 4005
2. Press  to change the RELAY function.  
PRESET:  
SETPNT: Select control for 12V DC alarm.
3. Press  to store.

The RELAY function defines what function the GT560 performs when the preset weight is activated during the unloading process. This can be held at 12 VDC while the Preset is active (PREACT), or activate 12 VDC once the Preset weight is reached during unloading (PRNOPA).

### 14.3 Time To Continue Preset Active Signal







1. Enter 6303(Enable 90019).
2. Press .
3. Enter time for PAST settings, if needed.
4. Press  to store.

The PAST setting is the time (0.0 to 99.9 seconds) for the RELAY function to timeout. If RELAY is set as PREACT and is held at 12 VDC output during the entire unload process, this setting extends the time at which the relay Remains at 12 VDC output. If RELAY is set as PRNOPA and activates 12 VDC output at the end of the unload cycle, this setting determines how long the output stays on after the target weight is reached.



**14.4 Select Weight Or Percentage Method**







1. Enter 4201.
2. Press .
3. Press  to choose WEIGHT or PRECENT; WEIGHT is preferred choice for this application.
4. Press  to store.
5. Next type in TOLER (Tolerance) value.
6. Press  to store.

This is normally the weight/percent value of grain still unloading; this is set to help prevent overfilling the truck. If the implement unloads by 1000 pounds too high each time, the TOLER value should be set to 1000.

7. Enter preset weight to be unloaded.
8. Press .

If 5000 pounds is entered, this is the range at which the relay functions above will activate.

**Example Application 1:** Grain cart with GT560 AutoLog<sub>2</sub> system is to activate an external alarm or light to notify truck driver that cart is unloading. Truck is allowed to hold 40,000 pounds. Grain cart operator opens and closes doors, and wants to make sure an additional 30 seconds are allowed for cleanout before truck drives away.

(Preset Active (PRA) has to be enabled, Service/Options Setting: 90019). Set 6302 ALP to ON, press  to store. Set 4005 RELAY to PRESET, press  to store. Set 6303 PAST to 30.0 (seconds), press  to store. Using key pad enter 40000, then press  to store preset weight value. To install, Connect green DC Output wire to external alarm or light +12V, black to - /Ground

**Operation:** Start PTO, GT560 automatically loads 40,000 pound preset, external alarm light flashes for truck driver. Open door to unload grain, then close door when near 40,000 pounds. Target weight is reached; 30 second delay time begins to give cart operator time to clean out the auger and turn off the PTO. After 30 seconds, external alarm light turns off, data is logged, and the truck drives away.

**Example Application 2:** Grain cart with GT560 AutoLog<sub>2</sub> system is to activate an alarm in tractor cab for 10 seconds to notify operator once 35,000 pounds is unloaded, so that the door can be closed. The operator has a history of overloading the truck by 5000 pounds each time.

Set 6302 ALP to ON. Set 4005 RELAY to PRNOPA. Set 6303 PAST to 10.0. Set 6003 to WEIGHT; TOLER to 5000. Press 35000 then  to store preset weight. Connect green DC Output wire to alarm +12VDC, black to ground.

**Operation:**

- Start PTO, GT560 automatically loads 35,000 pound preset.
- Open door to unload grain. Target weight is reached 5000 pounds early, sounding alarm for operator to close the door. The preset is deactivated at 30,000 pounds to correct for overfill, and the data is logged when the PTO is stopped.

### 15.0 RE-CALIBRATING THE SCALE

To change setup and calibration numbers see page 51.

To re-calibrate the scale and make it even more accurate, document at least 3 to 6 loads of varying sizes and measure the actual weight of all loads on a certified scale.

- It must be assured that each truck is not losing grain transit to a certified scale.
- Weigh the truck immediately before unloading and immediately after unloading to minimize errors due to changes in fuel etc.

In this example, six carts of grain are unloaded into four semi-trucks.

Example:

Cart Load A	51560		
Cart Load B	33240		
Cart Load C	17620	Truckload #1	51920
Cart Load D	50520	Truckload #2	51320
Cart Load E	38200	Truckload #3	50720
Cart Load F	12360	Truckload #4	51070
<b>Total Indicator Weight</b>	<b>203400</b>	<b>Total Certified Weight</b>	<b>205030</b>

#### Reading Too High

If the GT560 indicator is reading higher than the certified scale weight, then the calibration number is high and should be decreased proportionally.

#### Reading Too Low

If the GT560 indicator is reading lower than the certified scale weight, as shown in the example above, then the calibration number is low and should be increased proportionally.

### 15.1 View Current Calibration Number



1. Enter 8712

2. Press 

The calibration (CAL) number will display.  
Example **CAL = 24280**.

3. Press 



$$\frac{\text{TOTAL CERTIFIED WEIGHT}}{\text{TOTAL INDICATOR WEIGHT}} \times \text{CURRENT CAL NUMBER} = \text{NEW CAL NUMBER}$$

Using the previous example your results would be:

$$\frac{205030}{203400} \times 24280 = 24475$$

**15.2 Enter New Calibration Number**





1. Enter 8712
2. Press 
3. Existing calibration number will display.
4. Enter new number using keypad.
5. Press  to store.

For best results, unload on level ground. Make sure no grain is lost in trucking the grain to a certified scale.

**15.3 Changing/Viewing Setup Number**



1. Enter 8711
2. Press 
3. Current setup number will be displayed.
4. Enter new setup number using keypad.
5. Press  to store.

## 16.0 DAILY DATA COLLECTION

Insuring data is secure from theft, fire or equipment failure, requires a small effort each day to store data on a USB drive.

### Mid-Season Name Changes

During the season, you may wish to delete and add field names or ID names to the GT560 indicator memory. This may be done in one of two ways:

#### Front Panel:

For a small number of changes, edit field names and ID names using the keypad on the front panel. See page 20 to edit field names and ID names. See page 37 to erase accumulator memory.



#### Upload New Field Names, ID Names and Accumulator Using USB Drive:

For a large number of changes, perform the changes on your PC using Harvest Tracker software and then transfer the new information to the GT560 indicator using a USB drive.

NOTE: Before making any changes to field entries always transfer your existing field accumulator data from the GT560 indicator to the USB drive and onto your PC. This keeps the proper accumulator values on partially finished fields.

### 16.1 To Store Data Records On A USB Drive



1. Insert a USB drive into the USB port located on the bottom of the GT560 indicator. Wait for the GT560 to acknowledge the USB drive. USB IN will be displayed.
2. Press  to transfer the data record onto the USB drive.
3. Press 1 to transfer the field and ID names onto the USB drive.
4. Press .
5. Remove the USB drive from the USB port.

**NOTE:** All of the load records stored in the GT560 indicator are appended to the data in the USB drive each time you save records to the USB drive. **No data is ever lost.**

**USB Port Function**—the USB port is only to be used to upload or download data from a USB Memory Stick. The USB Port is not to be used as a charging port for any type of electronic device. Use of the USB Port for any purpose other than for which it is designed may void the product's warranty.



Clear the GT560 indicator memory before starting a season. Before starting the harvest each year, delete previous year's data records and accumulators. This is also a good time to add new field names and ID names to be stored.

**Important:** Before erasing the data records, be sure that the data records have been safely stored.

### 16.2 Erase Data Records From GT560 Indicator







Important: This action will erase all data records.



1. Enter 8211
2. Press 
3. Press  again to choose NO or YES.
4. Press  to erase all records if YES was selected.

### 16.3 Zero Accumulator Memory



1. Press  until ACCUM is displayed.
2. Press 
  - Press  to erase field 1 ACCUM.
  - Press  to erase all.
  - Press  to Exit.
3. Press  to return to main screen.

PRESS ZERO TO ERASE FLD 1 ACCUM  
PRESS FIELD TO ERASE ALL – ESC TO EXIT

**Note:** This operation only erases the accumulator Data, Field Names. ID names and data records are not affected.

## 17.0 OTHER FUNCTIONS

### 17.1 Backlight Dimmer





1. Press  until DIMMER is displayed.
2. Press  (Within 2 seconds) once to dim backlight on the LCD. Repeat steps 1 and 2 to brighten LCD backlight.

### 17.2 Unload Alarm



The unload alarm beeper can be set to:  
Off – no sound.  
1 – 10: Duration of sound (seconds).

To change unload alarm with active screen:

1. Enter 4004
2. Press 
3. Press  until desired setting is shown.
4. Press  to store setting and return to active Screen.

### 17.3 Change Time



1. Enter 1202
  2. Press
  3. Press or arrow to move cursor, and choose digit to edit.
- Note:** Press and hold to clear all digits. HH/MM/SS
4. Press or arrow to edit time.
  5. Press to store.
  6. Press to choose time format; AM/PM or 24 HOUR
  7. Press to store.

### 17.4 Change Date



1. Enter 1204
  2. Press
  3. Press or arrow to move cursor, and choose digit to edit.
- Note:** Press and hold to clear time.  
Date format **ddmmyy**.
4. Press or arrow to change number.
  5. Press to store.

17.5 Edit Sign On Message



1. Enter 8002

2. Press 

Sign on message can be enter in three sections using letter keypad. 6 characters per section can be entered. (Example; JIMS GRAIN FARM). Up to 7 six character section are available.

3. Press  to store after each section

Note: when GT560 is powered cycled, this message will scroll across display.



## 18.0 DIRECT ACCESS NUMBERS (D.A.N.)

### 18.1 Options Changed By User.

1. Use key pad to enter D.A.N. (direct access number) listed below.

2. Press 

3. Press  to select options for each setting/display.

4. Press  to store setting.

SETTING [DISPLAY]	D.A.N. NO.	OPTIONS [displayed] <b>BOLD</b> =DEFAULT	DESCRIPTION
<b>MENU 1 – GENERAL SETTINGS</b>			
LANGUAGE (LANGAG)	1001	English ( <b>ENGLISh</b> ) Portuguese (PORT) Spanish (ESPAñ) Danish (DANSK) Hungarian (MAGYAR) Spanish (VESTñ) Dutch (NEDERL) French (FRANCS) German (DEUTSH) Italian (ITALI)	Select language to be displayed.
DISPLAY RATE (DRATE)	1002	1,2,3,4,6,7,8,9,10	Update display times per second.
SCALE ID SETUP (SCALEID)	1003	<b>560WFI</b>	Identity of scale location (truck id or Mixer number).
ZERO TRACK (ZTRACK)	1004	<b>ON/OFF</b>	If ON -zero track adjust balance for buildup of snow & mud.
WEIGH METHOD (WATHD)	1005	<b>1=General</b> 2=Fast 3=Slow	Select weigh method. The speed the weight changes as shown on the LCD.
1 PRESS ZERO (1ZERO)	1006	<b>ON/OFF</b>	If ON -press and hold Zero key to Zero/Balance scale.

SETTING [DISPLAY]	D.A.N. NO.	OPTIONS [displayed] <b>BOLD</b> =DEFAULT	DESCRIPTION
AUTO OFF ( <i>AUTOFF</i> )	1007	<b>OFF</b> , 15, 30, 45, 60	Indicator turns off after selected minutes of stable weight.
DISPLAY UNIT ( <i>LB-KG</i> )	1008	<b>LB/KG</b>	Display pounds – LB or Kilograms - KG
SCROLL DELAY ( <i>SCROLL</i> )	1101	0,1,2,3,4, 5, 6, 7, 8, 9	Scroll rate for cold temperatures 0=normal 9=slowest
SAVE TARE ( <i>SAVTAR</i> )	1102	<b>ON/OFF</b>	Saves tare weight to non-volatile memory.
PRELOAD TARE ( <i>PRETAR</i> )	1103	<b>ON/OFF</b>	Tare weights can be entered using the numeric keypad.
TIME FORMAT ( <i>TIME F</i> )	1201	24 HR <b>AM/PM</b>	Select time format -AM/PM or 24 hours
TIME ( <i>TIME</i> )	1202	HH:MM:SS, AM/PM	Enter changes HH:MM:SS (use numeric keypad) use function key to change between HH:MM:SS then choose AM/PM.
DATE FORMAT ( <i>DATE F</i> )	1203	1-mm-dd 2-mm/dd/yy 3-mm/dd/yyyy 4-dd-mm 5-dd/mm/yy 6-dd/mm/yyyy <b>7-ddmmyy</b> 8-ddmmyyyy	Select date format
DATE ( <i>DATE</i> )	1204	Enter ddmmyy	Select key changes date or numerical keys -function key chooses DD/MM/YY.
DATE CHECK ( <i>DT CHK</i> )	1205	<b>ON/OFF</b>	Verifies the real time clock has a valid date at power up.
REMOTE INPUT 1 ( <i>RMINPT</i> )	1401	<b>MIXCTR</b> , INGRED,OFF, PRESET, SWITCH, TARE, PRINT, HOLD, NETGRS, M+, ZERO	Sets function of remote input line on the power cord.

SETTING [DISPLAY]	D.A.N. NO.	OPTIONS [displayed] <b>BOLD</b> =DEFAULT	DESCRIPTION
REMOTE 1 SWITCH STATE (R1STAT)	1403	OPEN/CLOSED	Set remote input line state that displays message and/or illuminates alarm lamp. <b>D.A.N. 1401 set to "switch"</b> .
REMOTE 1 SWITCH MESSAGE TIME (R1TIME)	1404	1...2-9	Set how often the remote switch message is displayed. Once every 1-9 seconds. <b>D.A.N. 1401 set to "switch"</b> .
REMOTE INPUT 2 (R2INP2)	1411	TARE, PRINT, HOLD, NETGRS, M+, ZERO, TR HLD, <b>OFF</b> , PRESET, SWITCH	Sets function of remote input line on the remote port.
REMOTE 2 SWITCH MESSAGE (R2MSG)	1412	<b>OPEN</b> ,--,+,*0, 1,2,3, 4,5,6,7,8,9,A,B,C,D,E,F,G,H,I,J, K,L, M,N,O,P,Q,R,S,T,U,-V,-W,-X,- Y,-Z	Message that is displayed for remote input condition. <b>D.A.N. 1411 set to "switch"</b> .
REMOTE 2 SWITCH STATE (R2STAT)	1413	OPEN/CLOSED	Set remote input line state that displays message and/or illuminates alarm lamp. <b>D.A.N. 1411 set to "switch"</b> .
REMOTE 2 SWITCH MESSAGE TIME (R2TIME)	1414	0...2-9	Set how often the remote switch message is displayed. Once every 1-9 seconds. <b>D.A.N. 1411 set to "switch"</b> .
PROGRAM ID (PRG ID)	1998	Example: 15FE16	Displays current software version
ESTIMATED WEIGHT (EST WT)	1999	Enter weight value using key pad. Then press enter, then "ON" to continue.	Manually adjust Gross weight of scale by changing zero/balance. Press "on" to continue.
<b>MENU 2 – COMMUNICATIONS FEATURES</b>			
REMOTE (REMOTE)	2001	<b>MLTLNE</b> , OFF, ON	If ON indicator communicates with Cab Control Display
SCALE NUMBER (SEL NO)	2002	<b>1,2,3,4,5,6,7,8,9,10,11,12,</b> 13,14,15,16,17,18,19,20, 21,22,23,24	Select scale number for cab control communication
EXTERNAL RADIO (EXTRAD)	2003	<b>ON/OFF</b>	Enables external radio to be connected to the J905 port.
DDL ATTACHED (DDL)	2004	<b>YES/NO</b>	Enables connection of a DDL (Data Down-Loader)

SETTING [DISPLAY]	D.A.N. NO.	OPTIONS [displayed] <b>BOLD</b> =DEFAULT	DESCRIPTION
SCOREBOARD MODE (SCOREM)	2101	0,1,2,3,4,5,6,7,8,11,12,15,27,37,38,39	Select scoreboard output
ZERO OUTPUT (ZEROUT)	2102	Weight displayed= Then press ZERO key and hold for three seconds.	Allows zero/balance for SCOREM #11 serial gross weight.
FRONT PANEL ZEROUT (ZEROFF)	2103	<b>OFF/ON</b>	Allows use of the zero key to zero/balance the serial gross weight.
OPERATION STATUS (OPSTAT)	2111	0, 2	Select operating data to be sent to a Remote Terminal
COM 1 BAUD RATE (C1BD)	2201	1200,2400, 4800, <b>9600</b> , 14400, 19200, 38400, 57600, 115200	Sets baud rate for com port #1
COM 1 PARITY (C1PR)	2202	NONE, ODD, <b>EVEN</b>	Sets parity for com port #1
COM 1 DATA BITS (C1DTR)	2203	7, 8	Sets data bits for com port #1
COM 1 DELAY (C1DLY)	2204	0, .10, .25, .50, .75, 1-5	Selects seconds to delay before advancing to next line.
COM 2 BAUD RATE (C2BD)	2211	1200,2400, 4800, <b>9600</b> , 14400, 19200, 38400, 57600, 115200	Sets baud rate for com port #2
COM 2 PARITY (C2PR)	2212	<b>NONE</b> , ODD, EVEN	Sets parity for com port #2
COM 2 DATA BITS (C2DTR)	2213	7, <b>8</b>	Sets data bits for com port #2
COM 2 DELAY (C2DLY)	2214	0, .10, .25, .50, .75, 1-5	Selects seconds to delay before advancing to next line.
TARE AUTO PRINT (TAREAP)	2301	ON/ <b>OFF</b>	If ON -tare auto-prints displayed weight.
ONE LINE PRINT (1L PRT)	2302	ON/ <b>OFF</b>	If ON -indicator data prints on one line.
AUTO PRINT (APRINT)	2303	ON/ <b>OFF</b>	If ON -pressing keys auto-prints weight values.

Direct Access Numbers (D.A.N.)

SETTING <i>[DISPLAY]</i>	D.A.N. NO.	OPTIONS [displayed] <b>BOLD</b> =DEFAULT	DESCRIPTION
PRINT FORMAT <i>(PRTFMT)</i>	2304	PRTAC1, PRTAC2, PRTAC3, PRTAC4, <b>PRTAC5</b> , PRTAC6, 10K TA, GT560A, RECINF, AUTO, WTONLY, DOWLD, DT + TM, ID + TM, IDWTTM, BATCH1, PRWTRC, WTRCTM, 3200-A, 3200-B, SCL ABC	Select alternate & comma (CSV) formats.
PRINT ACCUMULATION <i>(PRTACC)</i>	2305	<b>0</b>	Shows a running total of weights printed.
REMOTE DISPLAY <i>(RMDISP)</i>	2401	<b>EZ2</b> , EZ3MUX, COG, NONE	Select type of remote display
REMOTE TERMINAL <i>(RMTERR)</i>	2402	ON/OFF	Sends display data to serial remote terminal interface
BAR GRAPH MODE <i>(BARGRP)</i>	2411	OFF, <b>RIGHT</b> , LEFT, MIDOUT, MID IN	Selects output for a bar graph display when used with an RD4000 Remote Display
WEIGHT GRAPH <i>(WTGRPH)</i>	2412	ON/OFF	Enables graph to be used with weight when used with a RD4000 Remote Display.
BAR WEIGHT <i>(BAR WT)</i>	2413	<b>12000</b>	Enter the full scale gross weight for the bar graph display.
PRESET GRAPH <i>(PRGRPH)</i>	2414	ON/OFF	Enables graph use with presets when used with an RD4000 Remote Display.
TIMER GRAPH <i>(TMGRPH)</i>	2415	ON/OFF	Enables graph use with timers when used with an RD4000 remote display.
<b>MENU 3 - MOTION &amp; WEIGHT</b>			
DISPLAY COUNT <i>(COUNT)</i>	3001	.01,.02,.05,.1,.2,.5,1,2,5,10,20, 50, <b>100</b>	Select display count size of weigh values.
CAPACITY <i>(CAP)</i>	3002	<b>120,000</b>	Enter MAXIMUM weight measurable on scale.
WM1 ADJUST 1 <i>(WMA1-1)</i>	3003	<b>10</b>	Increase this number to smoothing weighing
WM1 ADJUST 2 <i>(WMA1-2)</i>	3004	4	0=off. Use value less than WMA1-1 for quick response weight.
WM1 ADJUST 3 <i>(WMA1-3)</i>	3005	<b>4000</b>	Enter the weight to active quick response weight Default-10% of scale capacity

Direct Access Numbers (D.A.N.)

SETTING [DISPLAY]	D.A.N. NO.	OPTIONS [displayed] <b>BOLD</b> =DEFAULT	DESCRIPTION
WM2 ADJUST 1 (WMA2-1)	3006	<b>30</b> , value must be less than 100 and more than 2.	Increase this number to smooth out weighing
WM2 ADJUST 2 (WMA2-2)	3007	<b>10</b> , value must be less than 100 and more than 0.	10=off. Use value less than WMA2-1 for quick response weight.
WM2 ADJUST 3 (WMA2-3)	3008	<b>4000</b>	Enter the weight to active quick response weight Default-10% of scale capacity
MOTION (MOTION)	3101	<b>ON/OFF</b>	ON = Motion arrow flashes with unstable weight. Prevents: Print, Zero, Tare, Advance
MOTION WEIGHT (MOT WT)	3102	<b>0</b>	Enter weight used to detect motion. 0=Standard detection
<b>MENU 4 - PRESET, ALARM, and TIMER</b>			
PRE ALARM METHOD (P MTHD)	4001	<b>WEIGHT, PERCENT</b>	Select weight or percentage method for pre-alarm
PRE-ALARM (P-ALM)	4002	<b>100</b>	Enter a value to activate an early warning that indicator is reaching the preset.
ALARM OUTPUT (AL OUT)	4003	<b>OFF, PRESET, TR</b>	Select preset or TR to control relay, horn & lamp.
BUZZER (BUZZER)	4004	<b>OFF, ON, 1-10</b>	ALARM BUZZER -allows user to turn off alarm horn when loading/unloading
RELAY (RELAY)	4005	<b>OFF, PRESET, SETPNT, SSPRAST</b>	Selects the behavior of the +12VDC alarm output
PRESET DELAY (PRTDLY)	4006	<b>0, MANUAL</b>	Set time to automatically advance/print entered preset
GROSS SET PNT OUTPUT (SETOUT)	4101	<b>OVER/UNDER</b>	Select when the +12VDC Alarm Output becomes active.
GROSS SET POINT CHNG (SETCHG)	4102	<b>500</b>	Set required weight change to turn off +12VDC Alarm Output.
GROSS SET POINT DELAY (SETDEL)	4103	<b>0</b>	Set time delay before the +12VDC Alarm Output can Turn On/Off.
GROSS SET POINT (SETPNT)	4104	<b>5000</b>	Set a gross weight in long form that will activate +12VDC Alarm Output on Power cord.

SETTING [DISPLAY]	D.A.N. NO.	OPTIONS [displayed] <b>BOLD</b> =DEFAULT	DESCRIPTION
SET POINT COUNT (SETCTR)	4105	<b>0</b>	Counts how many times set point is activated.
SET POINT WEIGHT SOURCE (STWTSC)	4106	SERIAL/ <b>NORMAL</b>	Sets weight source for use with set point feature.
TOLERANCE METHOD (TATHD)	4201	<b>WEIGHT</b> , PERCENT	Select weight or percentage method for preset tolerance
TOLERANCE (TOLER)	4202	<b>0</b>	Select tolerance weight percentage to accept preset.
TOLERANCE OVERLOCK (OVERLK)	4203	<b>OFF</b> /ON	Prevents auto-advancing if preset exceeds tolerance
DRIVE RATIO (DRATIO)	4302	<b>1.00</b>	Enter the number of input pulses that equal 1 mixer revolution. REVCTR needs to be enabled in the setup options. <b>D.A.N. 4301 set to COUNTER.</b>
<b>MENU 5 - COM PORT SETU MENU 5</b>			
REMOTE DISPLAY PORT (RMDPRT)	5001	OFF, COM1, <b>COM2</b> , COM3, COM4	Sets serial remote display output
RADIO PORT (RADPRT)	5002	OFF, COM1, COM2, <b>COM3</b> , COM4	Sets internal radio port
EXTERNAL RADIO PORT (EXRPRT)	5003	OFF, COM1, <b>COM2</b> , COM3, COM4	Sets external radio port
PRINTER PORT (PRPRT)	5005	OFF, <b>COM1</b> , COM2, COM3, COM4	Sets printer port
SCOREBOARD PORT (SCPRT)	5006	OFF, <b>COM1</b> , COM2, COM3, COM4	Sets scoreboard port
OPSTAT PORT (OPSTRT)	5007	OFF, <b>COM1</b> , COM2, COM3, COM4	Sets op-stat port

SETTING [DISPLAY]	D.A.N. NO.	OPTIONS [displayed] <b>BOLD</b> =DEFAULT	DESCRIPTION
DDL PORT (DDLPRT)	5009	OFF, COM1, <b>COM2</b> , COM3, COM4	Sets DDL port
20MA MIRROR PORT (20MARR)	5011	OFF, <b>COM1</b> , COM2, COM3, COM4	Sets port for 20MA signal to mirror
DEBUG PORT (DBGPRT)	5999	<b>OFF</b> , COM1, COM2, COM3, COM4	Sets debugger port
<b>MENU 6.3 – PRESET ACTIVE SIGNAL</b>			
UNLOAD WEIGHT DISPLAY (UNWEDI)	6301	<b>NET</b> , LOAD, GROSS	NET= weight from zero, LOAD= weight from preset, GROSS= total weight (90019—Enabled)
AUTO LOAD PRESET (ALP)	6302	<b>OFF</b> , STORED, TRUCK, PARTCP	Load stored preset weight when load/unload begins. (90019—Enabled)
PRESET ACTIVE SIG. TIMEOUT (PRST)	6303	ADD NUMBER OF SECONDS	Time in seconds between 1.0 – 99.9 to timeout the preset signal. (90019—Enabled)
UNLOAD ALARM (U ALRM)	6304	<b>OFF</b> , 1, 2, 3, 4, 5	Select OFF or time to sound buzzer in seconds. (90019—Enabled)
OUTPUT TOLERANCE METHOD (OTMTHD)	6305	<b>WEIGHT</b> , PERCNT	Select tolerance method weight or percentage. (90019—Enabled)
OUTPUT TOLERANCE (OTOLER)	6306	ENTER VALUE	Enter value greater than zero to use tolerance. (90019—Enabled)
<b>MENU 6.4 - AUTOLOG</b>			
RPM START/STOP CONTROL (RSSCTL)	6401	<b>RPM</b> , SWITCH, MANUAL	ON enables AUTOLOG feature (RPM automatic start/stop control feature)
RPM STOP SPEED (RSSMIM)	6402	<b>300</b>	Set to 20-50% of PTO operating PRMs. Stop is activated using this value.
RPM START TOL SPEED (RSSTDL)	6403	<b>100</b>	Set to 10% of PTO operating RPMs. Start is activated using this value + D.A.N. 6402.

Direct Access Numbers (D.A.N.)



SETTING [DISPLAY]	D.A.N. NO.	OPTIONS [displayed] <b>BOLD</b> =DEFAULT	DESCRIPTION
RPM START DELAY (R55PDY)	6404	<b>2.0</b>	Start activated when RPMs above D.A.N. 6402 + D.A.N. 6403 for this time in seconds.
RPM STOP DELAY (R55PDS)	6405	<b>2.0</b>	Stop activated when RPMs below D.A.N. 6402 for this time is seconds.
RMT CC STRAT STOP ENABLE (RACEN)	6406	<b>ON, OFF</b>	If ON – Enables Cab Control start/stop control.
GPS TRIGGER TOLERANCE (GPSTOL)	6408	<b>1000</b>	Enter weight change that will trigger GPS recording.
GPS STARTUP ENABLE (GPSHOW)	6409	<b>SHOW, HIDE</b>	Enables GPS Satellite screen upon startup.
FEEDBOX STRT/STP POLARITY (FSPOL)	6411	<b>CLOSE, OPEN</b>	Select Open or Close to activate automatic Start/Stop.
<b>MENU 6.8- MOISTURE</b>			
MOISTURE WEIGHT TOLER (MWTHRD)	6801	<b>300</b>	Enter unloaded weight to indicate flow over sensor.
SHOW CURRENT MOISTURE (SHOWMT)	6802	Example; 14.44	Displays current moisture value.
SHOW MOISTURE TEMP. (SHOWTMP)	6803	Example; 70.00	Display current temperature in Fahrenheit.
SHOW BUSHEL WEIGHT (BUSHOW)	6804	<b>OFF, ON</b>	Shows bushel weight on active screen.
CLEAR VOLTAGE MEMORY (CLRMMV)	6894	<b>NO, YES</b>	Clears all moisture voltage data.
MOISTURE VOLT. RECORDS (MVMREC)	6896	<b>NO, YES</b>	Displays the number of voltage records in memory.
SAVE MOISTURE VOLT. REC. (SAVMOV)	6897	<b>NO, YES</b>	Save moisture voltage records to USB.
SAVE ALL MOIST. RECORDS (MODUMP)	6898	<b>NO, YES</b>	Saves all moisture data to USB.

Direct Access Numbers (D.A.N)

SETTING [DISPLAY]	D.A.N. NO.	OPTIONS [displayed] <b>BOLD</b> =DEFAULT	DESCRIPTION
MOISTURE DEBUG (#DEBUG)	6899	<b>OFF</b> , ON	If ON – output debug messages through serial port.
CLEAR VOLTAGE MEMORY (CLRDMV)	6894	<b>NO</b> , YES	Clears all moisture voltage data.
MOISTURE VOLT. RECORDS (#VWREC)	6896	<b>NO</b> , YES	Displays the number of voltage records in memory.
SAVE MOISTURE VOLT. REC. (SAVMOV)	6897	<b>NO</b> , YES	Save moisture voltage records to USB.
SAVE ALL MOIST. RECORDS (#DDUMP)	6898	<b>NO</b> , YES	Saves all moisture data to USB.
MOISTURE DEBUG (#DEBUG)	6899	<b>OFF</b> , ON	If ON – output debug messages through serial port.
<b>SETUP FEATURES</b>			
SIGNON SETTING (SIGNON)	8001	<b>OFF</b> , ON	Enables continuous display of sign-on message
SIGNON MESSAGE (SIGNSG)	8002	SIGMSG 1,2,3	Enables editing of the sign-on message
MAINTENANCE MESSAGE (#MNTMG)	8011	MANTMG 1, 2, 3, 4, 5, 6, 7, 8, 9, 10	Enables editing of the maintenance message
MAINTENANCE MESS. TIME (#MNTTM)	8012	<b>200</b> , Time is entered using key pad.	Time for maintenance message to be triggered.
DEAD WEIGHT CAL (WT CAL)	8121	Follow instructions shown on LCD	Calibration method using weights
TEMPERATURE CALIBRATION (T CALB)	8123	OFF/ <b>ON</b>	On=Scale adjusts for temperature changes
INDICATOR SETUP INFO (DS>SER)	8299	<b>DS&gt;SER</b>	Downloads all setup information to the serial port
KEYTEST	8888		Enables front panel key test

Direct Access Numbers (D.A.N.)

SETTING (DISPLAY)	D.A.N. NO.	OPTIONS [displayed] <b>BOLD</b> =DEFAULT	DESCRIPTION
<b>SETUP &amp; CALIBRATION</b>			
SETUP NUMBER ( <i>SETUP</i> )	8711	<b>146040</b>	Quick entry method selects weigh method 1-4lbs, 5-8 kg, gain 1-9, display counts 1-9 and capacity *1000
Calibration Number ( <i>CAL</i> )	8712	<b>32640</b>	Weight displayed at 0.4mV/V
<b>Entering the service menu is required to use the 9000 series numbers. Contact service department for assistance.</b>			
RS232 OPTION ENABLE ( <i>RS-232</i> )	90003	<b>RS OFF</b> , RS-232	Enables/disables serial port
HOLD OPTION ENABLED ( <i>HOLD</i> )	90007	<b>HOLD</b> , HLD OFF	Enables the HOLD key functionality
MEMORY OPTION ENABLED ( <i>MEMORY</i> )	90008	<b>MEMERY</b> , MEM OFF	Enables/disables the M+, RM, CM options in the SELECT/FUNCTION key menu.
TIMER OPTION ENABLED ( <i>TIMER</i> )	90011	<b>TMR MX</b> , TMR OFF	Allows countdown timer to be set using the TIMER key.
INTERNAL RADIO ENABLED ( <i>RADIO</i> )	90012	<b>RA OFF</b> , RADIO	Enables/disables radio—requires radio hardware
ROTATION COUNTER ( <i>REVCTR</i> )	90016	<b>REVCTR</b> , REV OFF	Enables/disables rotation counter
GPS ENABLED ( <i>GPS</i> )	90017	<b>ENABLE/DISABLE</b>	GPS
GRAIN MOISTURE SENSOR ENABLE ( <i>MOISTR</i> )	90018	<b>ENABLE/DISABLE</b>	Moisture Functionality
PRESET ACTIVE SIGNAL ( <i>PRACTV</i> )	90019	<b>ENABLE/DISABLE</b>	Preset active signal functionality
NUMBER KEYPAD ENABLED ( <i>NUMKEY</i> )	90051	<b>NUMKEY</b> , NUM OFF	If ON—Enables front panel number pad.
MODEL IDENTIFICATION ( <i>MODELID</i> )	90201	<b>3610</b>	Allow entry of specific model ID to be display at power up.

Direct Access Numbers (D.A.N)

SETTING {DISPLAY}	D.A.N. NO.	OPTIONS [displayed] <b>BOLD</b> =DEFAULT	DESCRIPTION
MODEL ID TIME (MODELTM)	90202	1, 2, 3, 4, 5, 6, 7, 8, 9, 0	If ON---Entry amount of time for MODEL ID to be display at power up.
CLEAR PEAK WEIGHT (CLRPKW)	90302	<b>NO</b> / YES	If ON—Allows clearing of stored Peak weights
CLEAR ROTATION COUNTER (CLRREV)	90303	<b>NO</b> / YES	Allow clearing of stored rotation counts
CLEAR HOUR METER (CLRHR5)	90304	<b>NO</b> / YES	Allows clearing of hour meter
REINITIAZE (REINIT)	99999	<b>NO</b> / <b>YES</b>	Reset indicator to factory default settings. 3
GAIN CALIBRATION (GN CAL)	100001	<b>Starts Calibration Timer</b>	Enters gain calibration

Direct Access Numbers (D.A.N)

## 19.0 PRESET ACTIVE SIGNAL FUNCTIONALITY

Detailed below are different 12 VDC outputs available with the GT560.

### D.A.N. 4005 Settings:

- OFF – No 12VDC output will be activated.
  
- SETPNT – Set Point
  - Uses the weight threshold to activate and deactivate the 12VDC output.
- PRESET – Standard preset relay, lamp, and alarm functionality.
  - Uses the preset to determine the pulses of the light, buzzer, and 12VDC output.
- SEEDTD – Seed Tender
  - During unloading the 12VDC output is activated and once the preset is reached the light, buzzer, and the signal deactivates. The light and buzzer also pulse when the pre-alarm is active.
- PRNOPA – Preset No Pre Alarm
  - Uses the preset and pre alarm for the light and buzzer, but the 12VDC output is only activated by the preset being reached.
- SSPRST – Start/Stop Preset
  - Uses an entered or stored preset to activate the relay and also has the functionality of (PAST-D.A.N. 6303)
- PRACT – Preset Active Signal
  - During unloading the 12VDC output is active before the preset weight is reached and the output deactivates when the preset is reached. The light and buzzer are linked to the pre-alarm and active until unloading is complete.

### D.A.N. 4101 Settings:

This setting sets the state of the 12VDC output when PRESET, SEEDTD, PRNOPA, SSPRST or PRACT is selected in the D.A.N 4005 menu. The SIG 12V setting will configure the indicator to activate the 12VDC output when a preset weight is reached. The normal state of the signal will be 0V. The SIG 0V setting will maintain a 12VDC output when the preset is not active and will

Switch to 0V when the preset is active. The default mode is SIG 12V.

### D.A.N. 6303 Settings:

This setting determines the behavior of the 12VDC output when D.A.N 4005 is set to PRESET, SEEDTD, PRNOPA, SSPRST or PRACT. When a time between 0.1 to 99.9 seconds is entered, and D.A.N 4005 is set to PRESET the indicator will activate the 12VDC output when the preset is reached, delay for the specified time, and set the output to 0VDC after the delay period. When this is set to zero the 12VDC output will activate when the preset is reached and stay active until the preset is cleared. The preset is cleared when unloading stops. The default time is zero.

When unloading is stopped through the Start/Stop button or through AutoLog<sub>2</sub> the 12VDC output deactivates.

### D.A.N. 6003 Settings:

This setting allows the 12VDC output to activate before the preset is reached. It can be utilized in any D.A.N 4005 mode, other than OFF. The TOLER setting allows the operator to tune in the preset signal based on the intended equipment. The TOLER can be set to WEIGHT or PERCNT. This setting creates a window, based around the preset weight, and will activate the 12VDC output, according to the selected D.A.N 4005 configuration, when the measured weight is within that window.

**D.A.N 6301 Settings:**

This setting changes the normal view of the weight during the unloading process. There are three modes, NET, GROSS, and LOAD. Default mode is NET.

NET is the normal grain cart unloading method where the indicator counts down from zero and displays negative weight throughout the unloading.

GROSS allows the display of the actual or gross weight of the indicator and counts down from the total loaded weight.

LOAD displays the active preset weight and counts down from that value. If more than the prescribed preset is unloaded, the display will begin to count down from zero and show a negative number.

**D.A.N 6302 Settings:**

Determines if the preset is loaded when unloading begins, default is OFF. Every unloading cycle will use the loaded preset.

- OFF – No preset active.
  
- STORED – Enter an amount for the maximum truck capacity
  - Used every time no matter if different trucks with different capacities are used.
- TRUCK – Enter an amount for each truck
  - Used to enter a different preset amount depending on each trucks capacity.
- PARTCP – Enter any amount
  - Used if a less than full load is required.

To keep the 12VDC output signal deactivated during the unloading process when any D.A.N. 6302

setting is ON, press  before starting PTO.

## 20.0 12VDC OUTPUT DIAGRAMS

The diagrams on the following pages show the functionality of the 12VDC output when D.A.N 4101 is set to SIG 12V. SIG 0V reverses the output.

### 20.1 PRESET Active Signal Diagram

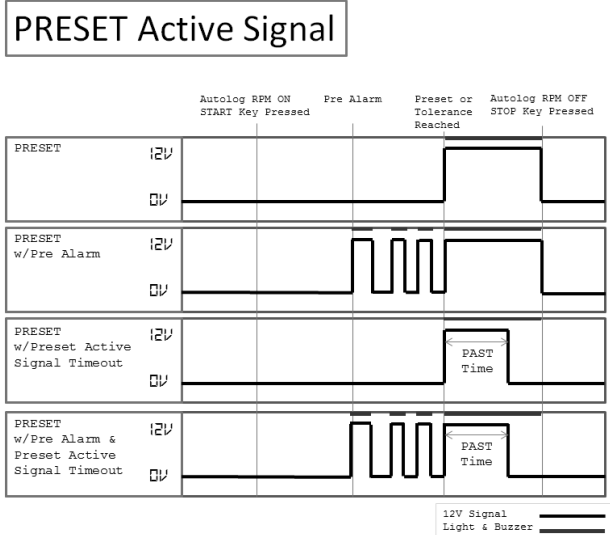

1) PMTHD RELAY SETOUT PAST	D.A.N. 4001 D.A.N. 4005 D.A.N. 4101 D.A.N. 6303	- P ALM = 0 - PRESET - SIG12V - 0.0	All modes require D.A.N. 6302 to be <u>Enabled.</u>
2) PMTHD RELAY SETOUT PAST	D.A.N. 4001 D.A.N. 4005 D.A.N. 4101 D.A.N. 6303	- PERCNT OR WEIGHT-PALM>10 - PRESET - SIG12V - 0.0	
3) PMTHD RELAY SETOUT PAST	D.A.N. 4001 D.A.N. 4005 D.A.N. 4101 D.A.N. 6303	- P ALM = 0 - PRESET - SIG12V - 5.0	
4) PMTHD RELAY SETOUT PAST	D.A.N. 4001 D.A.N. 4005 D.A.N. 4101 D.A.N. 6303	- PERCNT OR WEIGHT-PALM>10 - PRESET - SIG12V - 5.0	

20.2 SEEDTD Active Signal Diagram

SEEDTD Active Signal

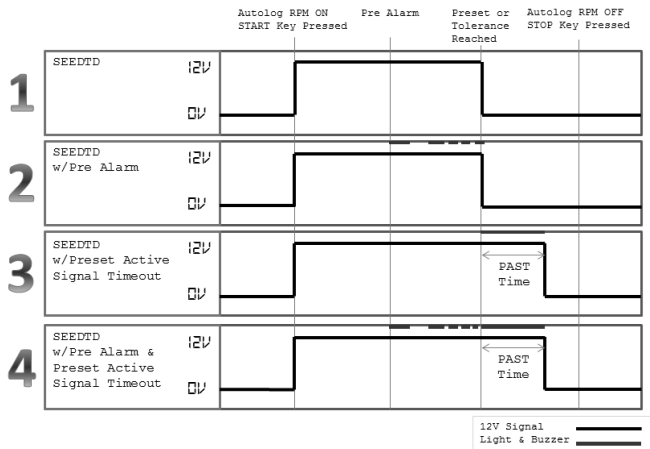

1) PMTHD RELAY SETOUT PAST	D.A.N. 4001 D.A.N. 4005 D.A.N. 4101 D.A.N. 6303	- P ALM = 0 - PRESET - SIG12V - 0.0	All modes require D.A.N. 6302 to be <b>Enabled.</b>
2) PMTHD RELAY SETOUT PAST	D.A.N. 4001 D.A.N. 4005 D.A.N. 4101 D.A.N. 6303	- PERCNT OR WEIGHT-PALM>10 - PRESET - SIG12V - 0.0	
3) PMTHD RELAY SETOUT PAST	D.A.N. 4001 D.A.N. 4005 D.A.N. 4101 D.A.N. 6303	- P ALM = 0 - PRESET - SIG12V - 5.0	
4) PMTHD RELAY SETOUT PAST	D.A.N. 4001 D.A.N. 4005 D.A.N. 4101 D.A.N. 6303	- PERCNT OR WEIGHT-PALM>10 - PRESET - SIG12V - 5.0	



20.3 PRNOPA Active Signal Diagram

PRNOPA Active Signal

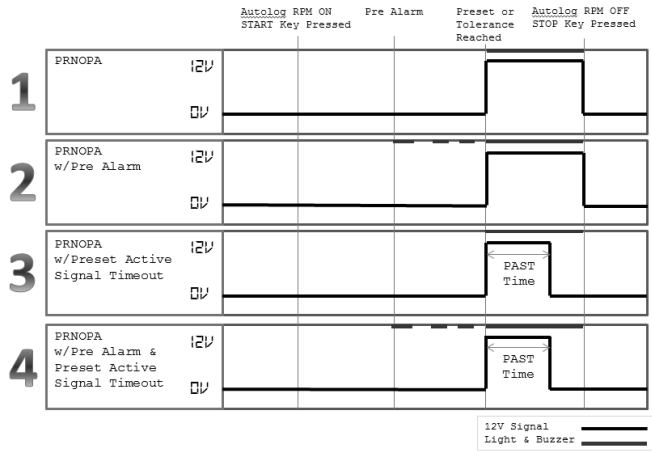

1) PMTHD RELAY SETOUT PAST	D.A.N. 4001 D.A.N. 4005 D.A.N. 4101 D.A.N. 6303	- P ALM = 0 - PRESET - SIG12V - 0.0	All modes require D.A.N. 6302 to be <u>Enabled.</u>
2) PMTHD RELAY SETOUT PAST	D.A.N. 4001 D.A.N. 4005 D.A.N. 4101 D.A.N. 6303	- PERCNT OR WEIGHT-PALM>10 - PRESET - SIG12V - 0.0	
3) PMTHD RELAY SETOUT PAST	D.A.N. 4001 D.A.N. 4005 D.A.N. 4101 D.A.N. 6303	- P ALM = 0 - PRESET - SIG12V - 5.0	
4) PMTHD RELAY SETOUT PAST	D.A.N. 4001 D.A.N. 4005 D.A.N. 4101 D.A.N. 6303	- PERCNT OR WEIGHT-PALM>10 - PRESET - SIG12V - 5.0	

20.4 PREACT Active Signal Diagram

PREACT Active Signal

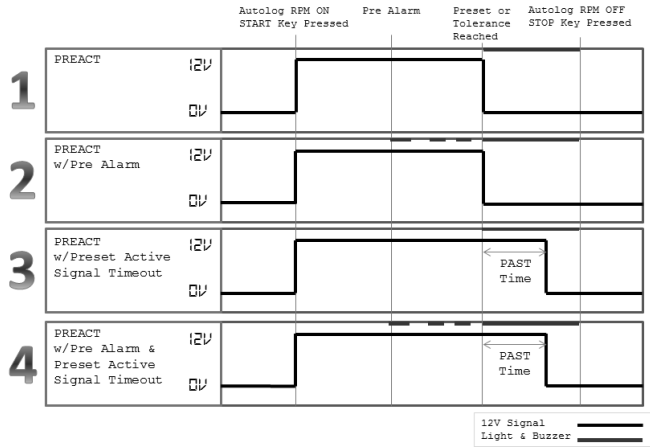

1) PMTHD RELAY SETOUT PAST	D.A.N. 4001 D.A.N. 4005 D.A.N. 4101 D.A.N. 6303	- P ALM = 0 - PRESET - SIG12V - 0.0	All modes require D.A.N. 6302 to be Enabled.
2) PMTHD RELAY SETOUT PAST	D.A.N. 4001 D.A.N. 4005 D.A.N. 4101 D.A.N. 6303	- PERCNT OR WEIGHT-PALM>10 - PRESET - SIG12V - 0.0	
3) PMTHD RELAY SETOUT PAST	D.A.N. 4001 D.A.N. 4005 D.A.N. 4101 D.A.N. 6303	- P ALM = 0 - PRESET - SIG12V - 5.0	
4) PMTHD RELAY SETOUT PAST	D.A.N. 4001 D.A.N. 4005 D.A.N. 4101 D.A.N. 6303	- PERCNT OR WEIGHT-PALM>10 - PRESET - SIG12V - 5.0	

## 21.0 WEIGHING ERROR MESSAGES

### 21.1 OVRCAP

Capacity Limit:

Weight on scale system exceeds capacity limit.

### 21.2 +RANGE

Over Range:

Weight on scale system exceeds maximum weight.

### 21.3 -RANGE

Under Range:

Weight on scale system less than minimum weight.

**22.0 TROUBLESHOOTING FLOW CHART**

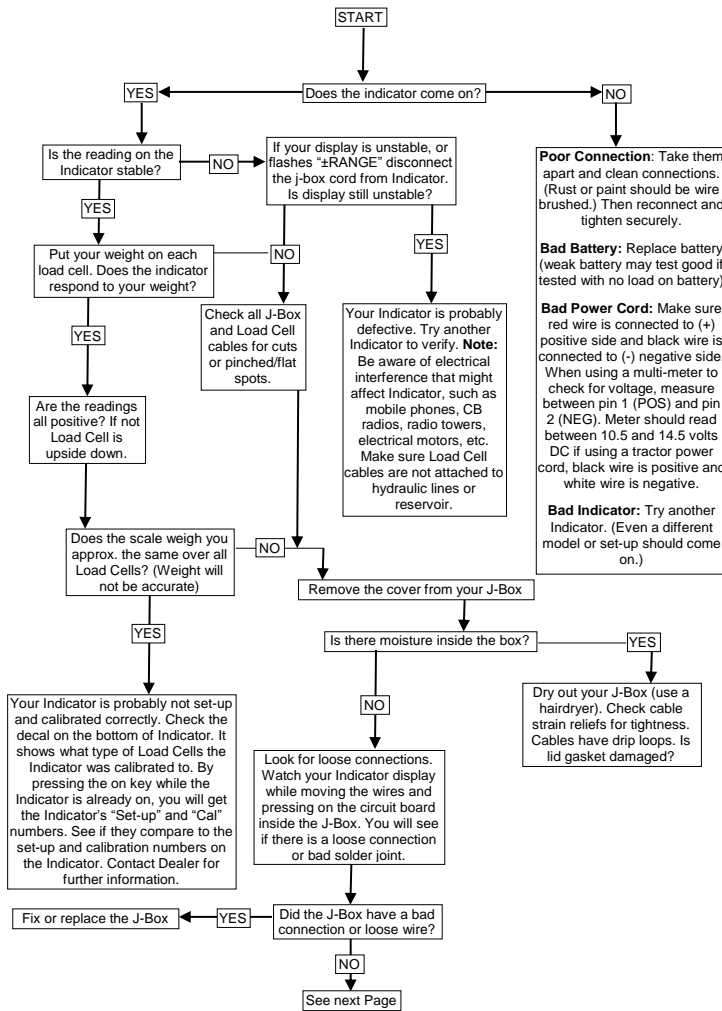

22.1 Troubleshooting Flow Chart Continued

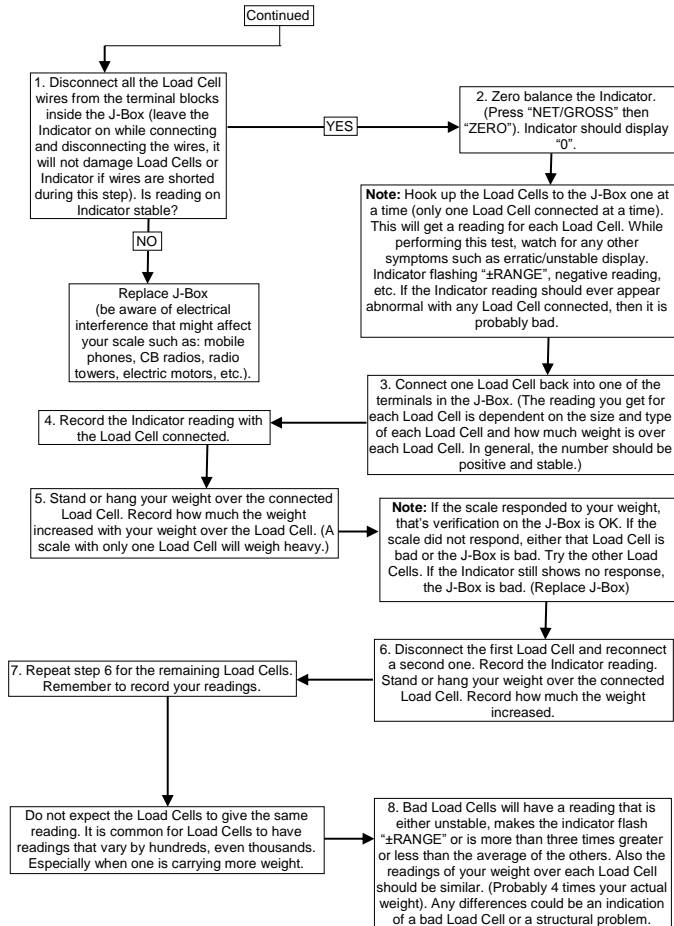

## 23.0 INSTALLATION

### 23.1 Indicator Mounting

For most applications the equipment manufacturer provides the necessary mounting system and hardware, and mounts the indicator for the end user.

Digi-Star provides a number of mounting options that allow the end user to customize the location and placement of the Indicator. The following section provides a list of the optional mounts.

In all cases the Digi-Star Indicator must be securely mounted to the equipment. Loose, or unsupported, indicators can be damaged.

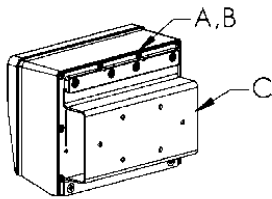

**STD UNIVERSAL  
MOUNT TALL**

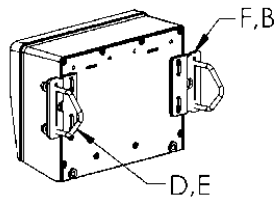

**WING MOUNT**

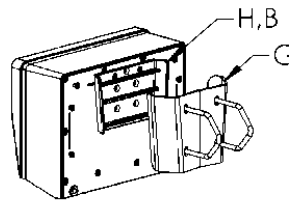

**WEDGE MOUNT**

KEY	PART NUMEBR	DESCRIPTION
A	404353	Bracket-EZ3 Plastic Rail *
B	403780	SCR-#10 X 5/8 FHSTS Black ZP
C	840459	Support-Hat Bracket
D	405069	U-Bolt 1/4-20 X 3.25 ZP
E	405084	Nut-1/4-20 Top Locking Flange
F	403770	Bracket- Wing Mount *
G	405124	Pack-Wedge Mount Bracket With U-Bolts & Flange Nuts
H	405244	EZ3 Wedge Mount

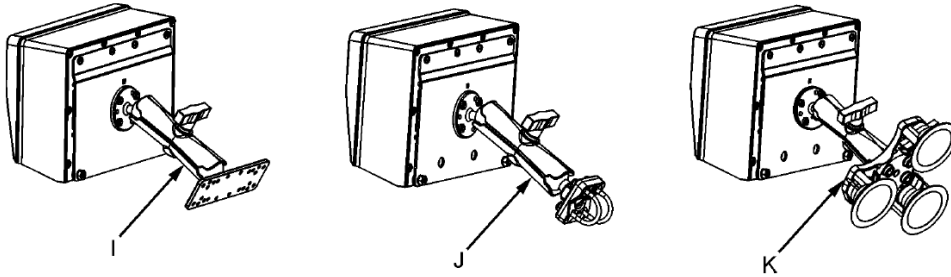

**RAM MOUNT**

KEY	PART NUMBER	DESCRIPTION
I	404799	Kit-1.5" Ram Mount With Bolt-On Base With Hardware
J	407544	Kit-1.5" Ram Mount With Dual U-Bolts (Fits 0.5"-1.5" Round)
K	407434	Kit-1.5" Ram Mount With Triple Suction Cup Base

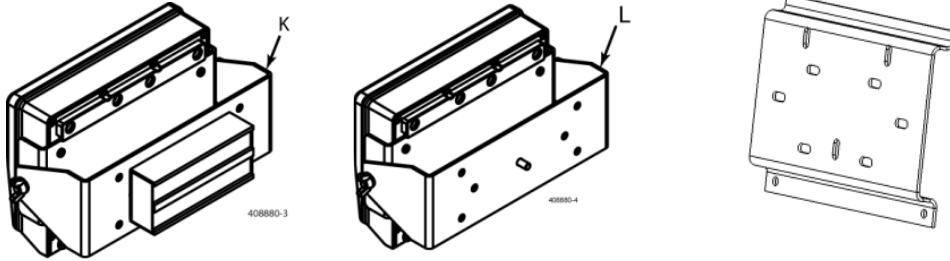

**SIDE & UNIVERSAL MOUNTS**

KEY	PART NUMBER	DESCRIPTION
K	408880	Mount For Large Indicators With Hardware and Magnet
L	408828	Mount for Large Indicators With Hardware Without Magnet
M	408199	Universal Mount Short



## 24.0 CABLE CONNECTIONS

For accurate and reliable operation care should be taken when routing and connecting cables to the Digi-Star Indicator.

Cables should be secured and protected from damage and abrasion.

Long cables should not “hang” by the cable connector at the Indicator but should be secured to a structure close to the Indicator leaving a short “tail” to connect to the Indicator.

### Special Considerations for Power (+) and Ground (-):

The Digi-Star Indicator is designed to operate at a continuous voltage ranging from 10.5 to 16.0 volts.

Intermittent voltage drops to as low as 9.0 volts, such as when starting an engine, will be tolerated.

Continuous low voltage will result in a Low Voltage warning on the display or the Indicator will power off.

Voltage spike above 16 volts will damage the Indicator. Never weld or charge the battery on the equipment that the Indicator is mounted to without disconnecting the Indicator power cord. Never operate an Indicator on equipment with an engine charging circuit when the battery has been removed.

Digi-Star recommends that the red power (+) and black ground (-) are connected as follows:

Power (+) can be either switched or keyed ON & OFF, or un-switched and always on.

Power (+) and Ground (-) should come from a dedicated auxiliary power source when provided. When auxiliary power sources are not provided power should come from the main power distribution system.

Fuse or circuit protection of at least 5 amps, but no more than 10 amps, should be provided. Although the indicator is protected internally by an internal fuse a fuse or circuit protection is required to protect the power cable and equipment.

Ground (-) connection should be made to a main ground (the battery ground (-) is often connected to this location). Do not use the chassis or frame of the equipment as a ground.

24.1 Indicator Connection Diagram

Pin	To 12VDC Power	
1	Red	+Terminal
2	Black	- Terminal
3	Orange	Alarm Out
4	Blue	Remote Input

Scale Indicator

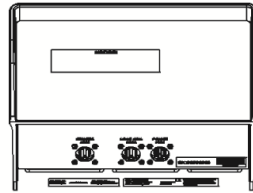

Remote Indicator  
(Option)

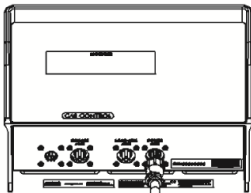

See Indicator  
Connection  
Diagram

Power Cord

See J-Box  
Connections

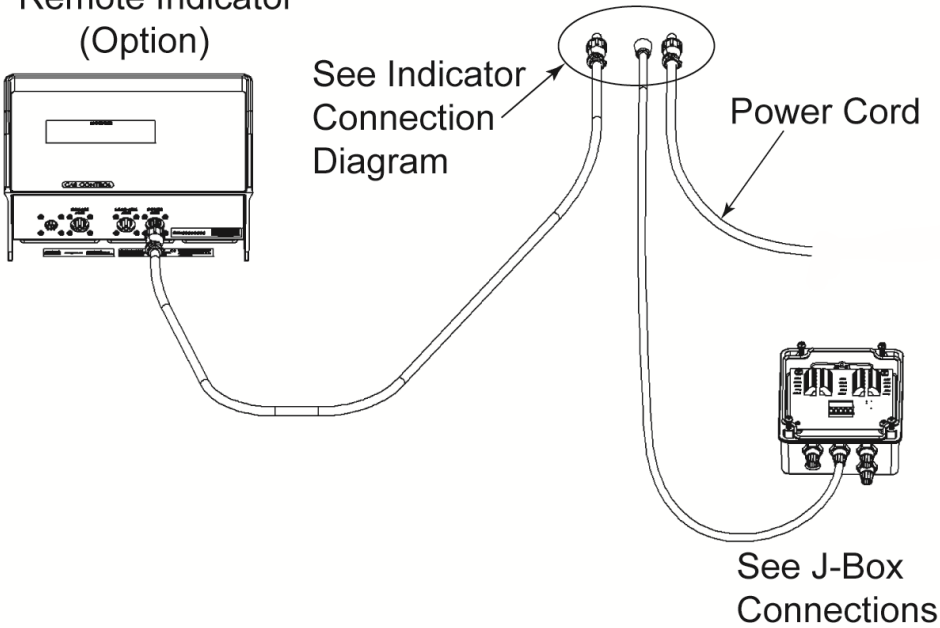

**24.2 Connecting Load Cells To Junction Box**

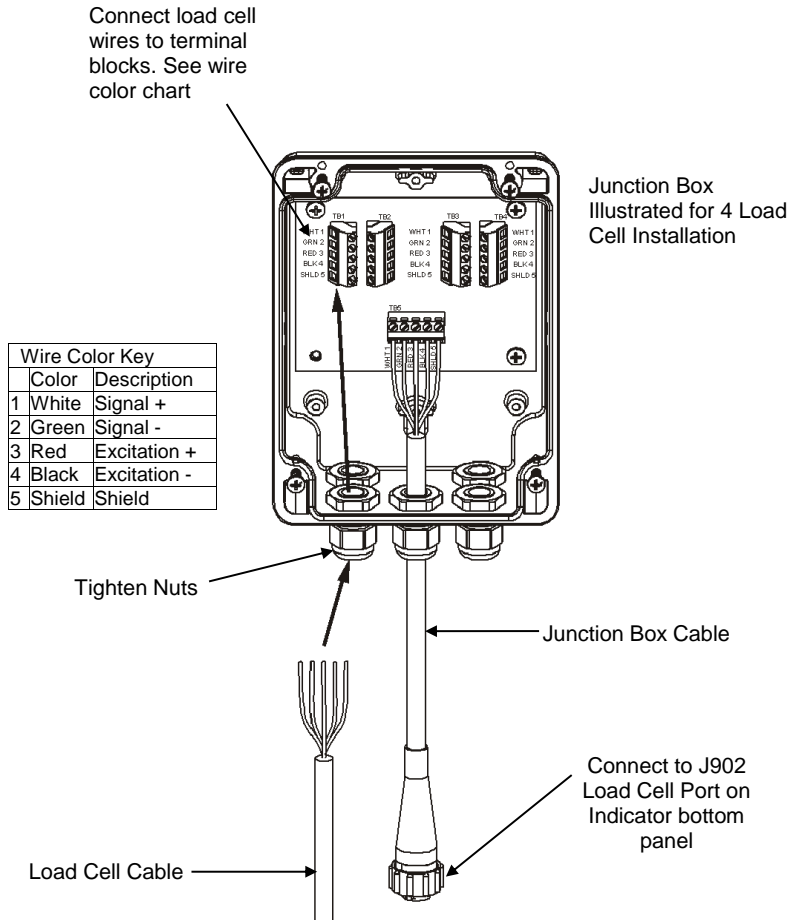

**24.3 Load Cell Direction**







Observe direction of arrow when installing load cell.

## 25.0 AUTOLOG TROUBLESHOOTING

If your system has been operating, execute the following sensor diagnostics to verify the RPM sensor is sending pulses to the indicator.

### RPM Sensor Diagnostics



1. Enter 7008 press 
2. Press  to select ON
3. Press 
4. Press  until DIAG is displayed.
5. Press 

Display will show value from RPM sensor.

Note: The RPM value should be close to the actual RPMs of the shaft.

For best results adjust the distance between the sensor and the target to between 0.1" and 0.2" (2mm to 5mm). This is equal to the thickness of one to two quarters.

Sensor has yellow LED indicator on rear to indicate target in range of the sensor.

DIAG is to be used as a diagnostic tool. Repeat steps 1 and 2 to select OFF once troubleshooting is complete.

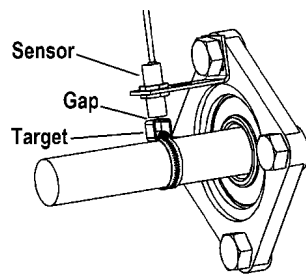

**SENSOR AND TARGET INSTALLATION**

## 26.0 SENSOR INSTALLATION AS PROXIMITY SWITCH

AutoLog sensor can now be used as a proximity switch on a door, gate, and door position indicator instead of a PTO. Mount sensor & target alongside the door while it is closed and change 3 D.A.N. settings on the GT560 (Listed below). When the door is opened, AutoLog starts recording the grain or forage being unloaded.

This feature allows AutoLog to be used in applications where no PTO is used, or where it is difficult to access. Since there are no high speed moving parts in this installation method, it is a highly reliable alternative to PTO mounting.









1. Determine location for mounting AutoLog sensor at door, gate, and door position indicator, or similar grain release control.
2. Sensor should be aligned with target when door is closed. **Shown in Figure 1.**
3. Mount metal target to door or gate.
4. Mount bracket to a fixed position next to door, aligned with target while the door is closed.
5. Mount sensor to bracket, about 1/8" from target (The thickness is approximately two quarters put together).
6. Route 3 pin AutoLog sensor cable toward GT560.
7. Connect sensor cable to 3 pin cable from GT560.
8. Verify yellow light of sensor is on with door closed.
9. Open door/ gate, verify light turns off, then close door (light on).
10. Turn on GT560.
11. Change these settings on the GT560 indicator:
  - a. Enter D.A.N. 1401. Press . Repeatedly press  until FSWITCH is displayed. Press  to store setting.
  - b. Enter D.A.N. 6401. Press . Repeatedly press  until SWITCH is displayed. Press  to store setting.
  - c. Enter D.A.N. 6411. Press . Repeatedly press  until OPEN is displayed. Press  to store setting.
12. Open door & verify GT560 displays START then UNLOAD.

Figure 1 shows an example of a proximity switch installation.



**27.0 DECLARATION OF CONFORMITY**

**EMC**

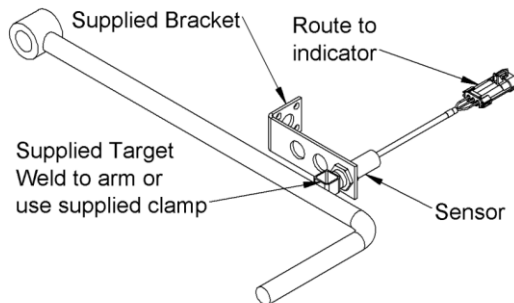
**DECLARATION OF CONFORMITY**

**Application of Council Directive(s)** 2004/108/EC

**Manufacturer's Name:** Digi-Star, LLC  
**Manufacturer's Address:** W5527 State Hwy 106  
Fort Atkinson, WI 53538

**European Representative Name:** Digi-Star International  
**European Representative Address:** J.F. Kennedylaan 235  
5981 WX Panningen  
The Netherlands

**Model Name:** GT560

**Conformance to:** § EN 61326-1 electrical equipment for measurement,  
control, and laboratory use (See Report Number 316064)  
§ EN 55011, for Class B ISM equipment for industrial,  
scientific, and medical equipment. (See Report Number  
316064.)

**Equipment Type/Environment:** Electronic weighing scale systems; not legal for trade.  
For agricultural, commercial and industrial use.

**Beginning Serial No.:** 00001001

**Year of Manufacture:** 2016

We, the undersigned, hereby declare that the equipment specified above conforms to  
the above Directive(s).

**Manufacturer**

**Legal Representative in Europe**



Signature

Signature

**Full Name:** Peter Nelson  
**Position:** Engineering Director  
**Place:** Fort Atkinson, WI U.S.A.  
**Date:** March 14, 2016

**Full Name:** Wim de Wit  
**Position:** Managing Director  
**Place:** Panningen, The Netherlands  
**Date:** March 14, 2016

---













**28.0 NOTES**

SETUP NUMBER \_\_\_\_\_















CALIBRATION NUMBER \_\_\_\_\_

## 29.0 QUICK REFERENCE AID





### FIELD SCREEN

- ① Press  to modify or select field. Current field number is shown in upper display.
- ② Three lines are displayed in Lower Display Window. The top line of the three is current, editable and will be used for next data record.
- ③ Up/Down Arrows – Press  or  to scroll through fields (150 maximum). Hold arrow to scroll faster. Use  or  to move cursor within data line.
- ④ Use keypad to enter or update field names. Press  to delete characters to left and  to delete the selected character. Hold  to delete entire line. Pressing  will reset line to last saved data.
- ⑤ To use special characters press and release . Then press key with desired special character. Repeat for each special character required.
- ⑥ Press  or  to exit.

### ID SCREEN

- ① Press  to modify or select ID name. Current ID number is shown in upper display.
- ② Three lines are displayed in Lower Display Window. The top line of the three is current, editable and will be used for next data record.
- ③ Up/Down Arrows – Press  or  to scroll through ID names (150 max.). Hold arrow to scroll faster. Use  or  to move cursor within data line.
- ④ Use keypad to enter or update ID names. Press  to delete characters to left and  to delete the selected character. Hold  to delete entire line. Pressing  will reset line to last saved name.
- ⑤ To use special characters press and release . Then press key with desired special character. Repeat for each special character required.
- ⑥ The operator will see ID XXX while editing the ID and CAP XXX while editing the capacity. After editing the ID press  to move the cursor to capacity field to enter capacity data. The display will scroll to the next ID when pressing  or .
- ⑦ Press  or  to exit.

### MOISTURE SCREEN

- ① Press  repeatedly until the text **GRAIN** is shown on the display, then release key. Press  key to enter.
- ② Up/Down Arrows – Press  or  to scroll through CROP names. When desired crop name is listed. Press  to select crop and return to weight screen.



**30.0 OPTIONS**



GPS Antenna  
Optional GPS "Puck" antenna with magnetic base and 17 feet of cord



Wi-Fi External Radio Module  
Optional module for use with Android or IOS phone or tablet



IPC Thermal Printer  
Optional printer a RS232 serial port is required which is labeled as SERIAL, J904 or J905 depending on model of indicator



Moisture Sensor  
Option sensor used with the GT560 to determine grain moisture and calculated dry bushels

AutoLog Sensor (not shown)  
Optional sensor kit for PTO or discharge gate